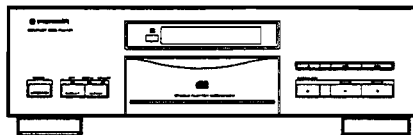


Service Manual

PIONEER®
The Art of Entertainment



ORDER NO.
ARP2527

COMPACT DISC PLAYER

PD-S95

PD-95

PD-S95 AND PD-95 HAVE THE FOLLOWING:

Type	Model		Power Requirement	Remarks
	PD-S95	PD-95		
KU/CA	○	—	AC120V only	
HEM	—	○	AC220-230V, 240V (switchable) *	

* Change the connection of the power transformer's primary wiring.

- This manual is applicable to PD-S95/KU/CA and PD-95/HEM.
- Ce manuel pour le service comprend les explications de réglage en français.
- Este manual de servicio trata del método ajuste escrito en español.

CONTENTS

1. SAFETY INFORMATION	2
2. LABEL CHECK	3
3. PACKING AND PARTS LIST	4
4. EXPLODED VIEWS AND PARTS LIST	5
5. SCHEMATIC AND PCB CONNECTIONS DIAGRAMS.....	14
6. PCB PARTS LIST	31
7. ADJUSTMENTS	36
7. REGLAGES	51
7. AJUSTES	66
8. IC INFORMATION	81
9. DISASSEMBLY	82
10. PANEL FACILITIES.....	83
11. SPECIFICATIONS	84

PIONEER ELECTRONIC CORPORATION 4-1, Meguro 1-Chome, Meguro-ku, Tokyo 153, Japan
PIONEER ELECTRONICS SERVICE INC. P.O. Box 1760, Long Beach, California 90801 U.S.A.
PIONEER ELECTRONICS OF CANADA, INC. 300 Allstate Parkway Markham, Ontario L3R 0P2 Canada
PIONEER ELECTRONIC [EUROPE] N.V. Haven 1087 Keetberglaan 1, 9120 Melsele, Belgium
PIONEER ELECTRONICS AUSTRALIA PTY. LTD. 178-184 Boundary Road, Braeside, Victoria 3195, Australia TEL: [03] 580-9911
© PIONEER ELECTRONIC CORPORATION 1992

SN MAY. 1992 Printed in Japan

This service manual is intended for qualified service technicians; it is not meant for the casual do-it-yourselfer. Qualified technicians have the necessary test equipment and tools, and have been trained to properly and safely repair complex products such as those covered by this manual.

Improperly performed repairs can adversely affect the safety and reliability of the product and may void the warranty. If you are not qualified to perform the repair of this product properly and safely, you should not risk trying to do so and refer the repair to a qualified service technician.

WARNING

Lead in solder used in this product is listed by the California Health and Welfare agency as a known reproductive toxicant which may cause birth defects or other reproductive harm (California Health & Safety Code, Section 25249.5).

When servicing or handling circuit boards and other components which contain lead in solder, avoid unprotected skin contact with the solder. Also, when soldering do not inhale any smoke or fumes produced.

1. SAFETY INFORMATION

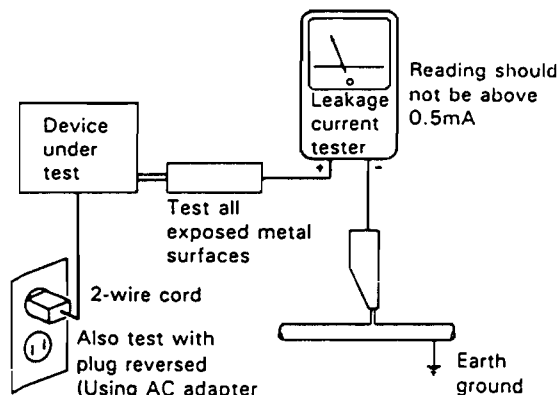
(FOR USA MODEL ONLY)

1. SAFETY PRECAUTIONS

The following check should be performed for the continued protection of the customer and service technician.

LEAKAGE CURRENT CHECK

Measure leakage current to a known earth ground (water pipe, conduit, etc.) by connecting a leakage current tester such as Simpson Model 229-2 or equivalent between the earth ground and all exposed metal parts of the appliance (input/output terminals, screwheads, metal overlays, control shaft, etc.). Plug the AC line cord of the appliance directly into a 120V AC 60Hz outlet and turn the AC power switch on. Any current measured must not exceed 0.5mA.



AC Leakage Test

ANY MEASUREMENTS NOT WITHIN THE LIMITS OUTLINED ABOVE ARE INDICATIVE OF A POTENTIAL SHOCK HAZARD AND MUST BE CORRECTED BEFORE RETURNING THE APPLIANCE TO THE CUSTOMER.

2. PRODUCT SAFETY NOTICE

Many electrical and mechanical parts in the appliance have special safety related characteristics. These are often not evident from visual inspection nor the protection afforded by them necessarily can be obtained by using replacement components rated for voltage, wattage, etc. Replacement parts which have these special safety characteristics are identified in this Service Manual.

Electrical components having such features are identified by marking with a Δ on the schematics and on the parts list in this Service Manual.

The use of a substitute replacement component which does not have the same safety characteristics as the PIONEER recommended replacement one, shown in the parts list in this Service Manual, may create shock, fire, or other hazards.

Product Safety is continuously under review and new instructions are issued from time to time. For the latest information, always consult the current PIONEER Service Manual. A subscription to, or additional copies of, PIONEER Service Manual may be obtained at a nominal charge from PIONEER.

2. LABEL CHECK

(FOR EUROPEAN MODEL ONLY)

VARO!
AVATTAESSA JA SUOJALUKITUS OHITETTAESSA OLET ALTTIINA NÄKYMÄTTÖMÄLLE LASERSÄTEILYLLE. ÄLÄ KATSO SÄTEESEEN.



LASER
Kuva 1
Lasersäteilyn varoitusmerkki

WARNING!
DEVICE INCLUDES LASER DIODE WHICH EMITS INVISIBLE INFRARED RADIATION WHICH IS DANGEROUS TO EYES. THERE IS A WARNING SIGN ACCORDING TO PICTURE 1 INSIDE THE DEVICE CLOSE TO THE LASER DIODE.



LASER
Picture 1
Warning sign for laser radiation

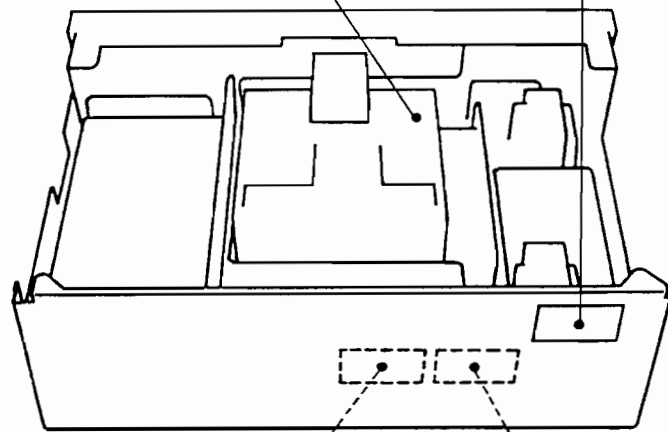
ADVERSEL:
USYNLIG LASERSTRÅLING VED ÅBNING NÅR SIKKERHEDSAFBRYDERE ER UDE AF FUNKTION UNGDÅ UDSÆTTELSE FOR STRÅLING.

IMPORTANT
THIS PIONEER APPARATUS CONTAINS LASER OF CLASS 1. SERVICING OPERATION OF THE APPARATUS SHOULD BE DONE BY A SPECIALLY INSTRUCTED PERSON.

VARNING!
OSYNLIG LASERSTRÅLNING NÅR DENNA DEL ÄR ÖPPNAD OCH SPÄRREN ÄR URKOPPLAD. BETRakta EJ STRÅLEN.

LASER DIODE CHARACTERISTICS
MAXIMUM OUTPUT POWER: 5 mw
WAVELENGTH: 780-785 nm

HEM type



ADVARSEL
USYNLIG LASERSTRÅLING VED ÅBNING NÅR SIKKERHEDSAFBRYDERE ER UDE AF FUNKTION. UNGDÅ UDSÆTTELSE FOR STRÅLING.
VORSICHT!
UNSICHTBARE LASERSTRÅLUNG TRITTT AUS, WENN DECCEL (ODER KLAPPE) GEÖFFNET IST! NICHT DEM STRAHLE AUSSETZEN!
VRW1054

VARO!
Avattaessa ja suojalukitus ohitettaessa olet alttiina näkymättömälle lasersäteilylle. Älä katso säteeseen.
VARNING!
Osynlig laserstrålning när denna del är öppnad och spärren är urkopplad. Betrakta ej strålen.
PRW1233

HEM type

Additional Laser Caution

- Laser Interlock mechanism**
The ON/OFF status of the clamp switch (S 102) for detecting loading completion is detected by the system microprocessor, and the design prevents laser diode oscillation when the clamp switch is OFF. Thus, the interlock will no longer function if the clamp switch (S 102) is deliberately shorted. In the test mode the interlock mechanism will not function (refer to page 36). Laser diode oscillation will continue if pin 4, 5, or 29 of CXA 1081 S(IC 1) is connected to ground or the terminals of Q 304 are shorted each other (fault condition).

- If the fault condition described in 1 is induced with the cover removed and the objective lens extending past the outer circumference of the disc clamped diameter, close viewing of the objective lens with the naked eye will cause exposure to a Class 1 laser beam.

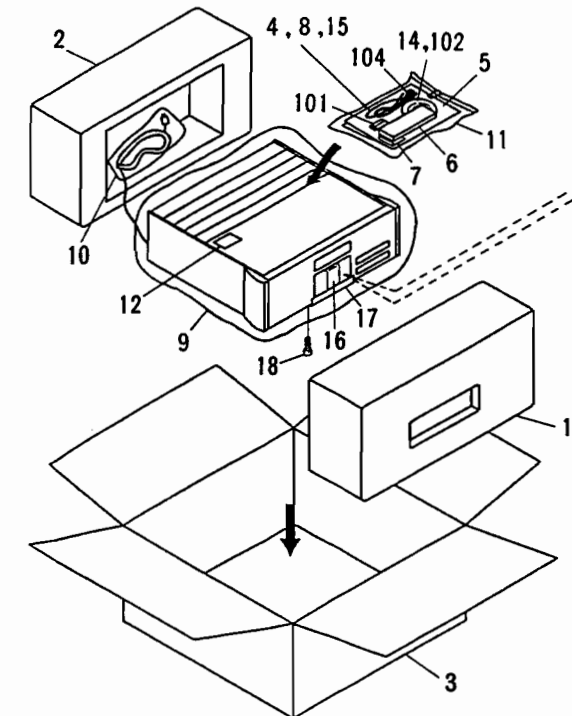
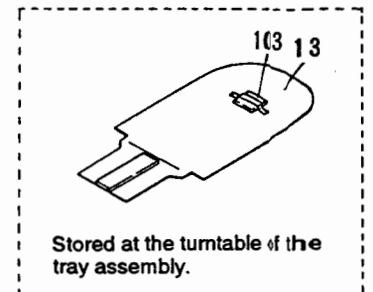
3. PACKING AND PARTS LIST

NOTES:

- Parts marked by "NSP" are generally unavailable because they are not in our Master Spare Parts List.
- The Δ mark found on some component parts indicates the importance of the safety factor of the part. Therefore, when replacing, be sure to use parts of identical designation.
- Parts marked by "⊙" are not always kept in stock. Their delivery time may be longer than usual or they may be unavailable.

Parts List

Mark	No.	Description	Part No.	Mark	No.	Description	Part No.
	1	Styrol protector (F)	PHA1176	NSP	101	Battery (R03, AAA)	VEM-022
	2	Styrol protector (R)	PHA1177	NSP	102	Turn table rubber	PEB1187
	3	Packing case (PD-95)	PHG1814	NSP	103	Spacer (rubber)	PEB1174
	4	Packing case (PD-S95)	PHG1815	NSP	104	Earth lead unit (PD-S95 only)	PDF1129
	5	Connection cord (PD-95 only)	PDE1032				
	5	Operating instructions (English/French)	PRE1165				
		Operating instructions (German/Italian/Dutch/Swedish/Spanish/Portuguese) (PD-95 only)	PRF1058				
	6	Wireless remote control unit	PWW1056				
	7	Battery cover	PZN1009				
	8	Cord with mini plug (PD-S95 only)	PDE-319				
	9	Mirror mat	VHL1012				
	10	Vinyl bag	Z21-037				
	11	Vinyl bag	Z21-038				
	12	Caution label	PRW1246				
	13	Sheet	PRW1245				
	14	Table rubber assembly	PEA1174				
	15	Video cord (PD-S95 only)	VDE1003				
	16	Styrol protector	PHC1057				
	17	Caution	PRM1025				
	18	Screw	PBA1065				



4. EXPLODED VIEWS AND PARTS LIST

NOTES:

- Parts marked by "NSP" are generally unavailable because they are not in our Master Spare Parts List.
- The Δ mark found on some component parts indicates the importance of the safety factor of the part. Therefore, when replacing, be sure to use parts of identical designation.
- Parts marked by "⊙" are not always kept in stock. Their delivery time may be longer than usual or they may be unavailable.

4.1 EXTERIOR

Parts List

Mark	No.	Description	Part No.	Mark	No.	Description	Part No.
	1	1P pin jack (PD-95)	PKB1017		31	Screw	CPZ30P080FMC
Δ	2	AC power cord (PD-95)	PDG1003		32	Side pole	PAN1224
Δ		AC power cord (PD-S95)	PDG1045		33	Side pole (R)	PAN1237
Δ	3	Power transformer (PD-95)	PTT1254		34	Side spacer	PEB1197
		Power transformer (PD-S95)	PTT1251		35	Caution label	PRW1244
Δ	4	Power transformer (PD-95)	PTT1255		36	Table assembly	PEA1255
	5	3P receptacle (PD-95)	PKP1006		37	Over tray	PNW2079
Δ	6	Power transformer (PD-95)	PTT1256		38	Screw	PBA1064
	7	Screw	IBZ30P080FCC		39	Spindle base assembly	PXA1421
	8	Upper board (F)	PNS1026		40	Holder	VNL - 268
	9	Side board	PAN1225		41	Damper sheet	PNM1125
	10	Upper board (R)	PAN1227		42	Damper rubber	PEB1146
	11	Washer	WH40FUC		43	E ring	YE30FUC
	12	Cord clamber	RNH - 184		44	Rotor assembly	PXA1392
	13	Power button	PAC1610	Δ	45	Spring	PBH1092
	14	Plate assembly	PXA1465		46	Turn table	PAN1267
	15	Screw	IBZ30P060FCC	Δ	47	Screw	BBZ30P060FCC
	16	Screw	PMZ26P060FNI		48	Ground terminal (PD-S95)	DKE - 101
	17	Screw	PDZ30P050FCC	Δ	49	BNC connectors (PD-S95)	PKB1018
	18	Screw	IBZ30P180FCC	NSP	101	PCB mold	AMR1525
	19	Screw	IBZ40P080FCC	NSP	102	Rear base (PD-S95)	PNA1712
NSP	20	Screw	BBT30P080FCC	NSP		Rear base (PD-95)	PNA1894
	21	Screw	IBZ30P100FCC	Δ	103	Strain relief (PD-95)	CM - 22B
NSP	22	Main board assembly (PD-95)	PWZ2212	NSP		Strain relief (PD-S95)	PNW2145
NSP		Main board assembly (PD-S95)	PWZ2213	NSP	104	Side angle	PNB1328
\odot	23	Analog board assembly (PD-95)	PWM1529	NSP	105	Audio case (PD-95)	PNB1332
	24	Screw	PBA1049	NSP	106	Switch angle	PNB1373
	25	Tape	PNM1129	NSP	107	Sash A	PAN1192
	26	Screw	IBZ30P150FCU	NSP	108	Stopper (rubber)	PEB1148
	27	Screw	IBZ30P060FCC	NSP	109	Base plate	PNA1711
	28		NSP	110	PCB spacer (PD-95)	PNY - 404
	29	Screw	VBA1027	NSP	111	Single mechanism assembly	PXA1461
	30	Plate	PBK1090	NSP	112	Tray assembly	PXA1447
				NSP	113	Plate spring ST	PBK1089
				NSP	114	PCB angle	PNB1205
				NSP	115	Spacer	PNM1019

Mark	No.	Description	Part No.
NSP	116	Transformer primary assembly (PD-95)	PWZ2217
NSP		Transformer primary assembly (PD-S95)	PWZ2218
NSP	117	Thrust holder	PNB1325
NSP	118	Rear panel (PD-95)	PAN1258
NSP		Rear panel (PD-S95)	PAN1259
NSP	119	Tray	PNA1782
NSP	120	Tray locker	PNW2014
NSP	121	Mechanism cover	PNB1402
NSP	122	Slide guide	PNW2080
NSP	123	Rack	PNW2081
NSP	124	Collar	PNW2012
NSP	125	Trans roof	PNB1331
NSP	126	AC shield plate	PNB1330
NSP	127	Angle (PD-95)	PNB1333
NSP	128	PCB angle M	PNB1334
NSP	129	PCB angle A (PD-95)	PNB1372
NSP	130	Edge cover 11 (PD-95)	PEC1018
NSP	131	Edge cover 15	PEC1019
NSP	132	Edge guard (B)	DEC1144
NSP	133	Plate	PAN1263
NSP	134	Tray rubber	PEB1198
NSP	135	Tray holder B	PNW2077
NSP	136	Line L board assembly (PD-95)	PWZ2320
NSP	137	Line R board assembly	PWZ2321
NSP	138	Ballance L board assembly (PD-95)	PWZ2223
NSP		BNC board assembly (PD-S95)	PWZ2326
NSP	139	Ballance R board assembly (PD-95)	PWZ2225

Exterior

A

B

C

D

A

B

C

D

1

2

3

4

5

1

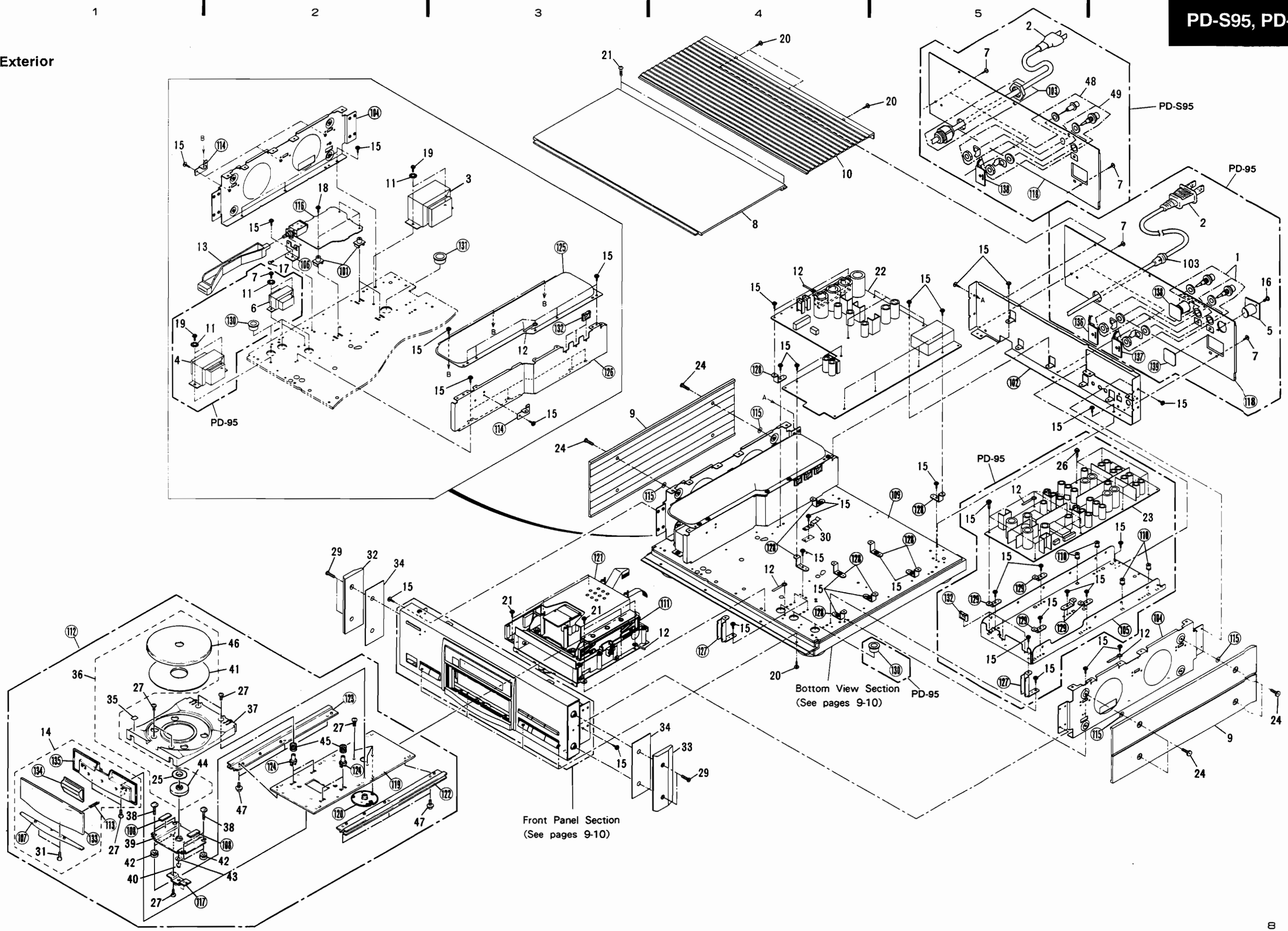
2

3

4

5

6



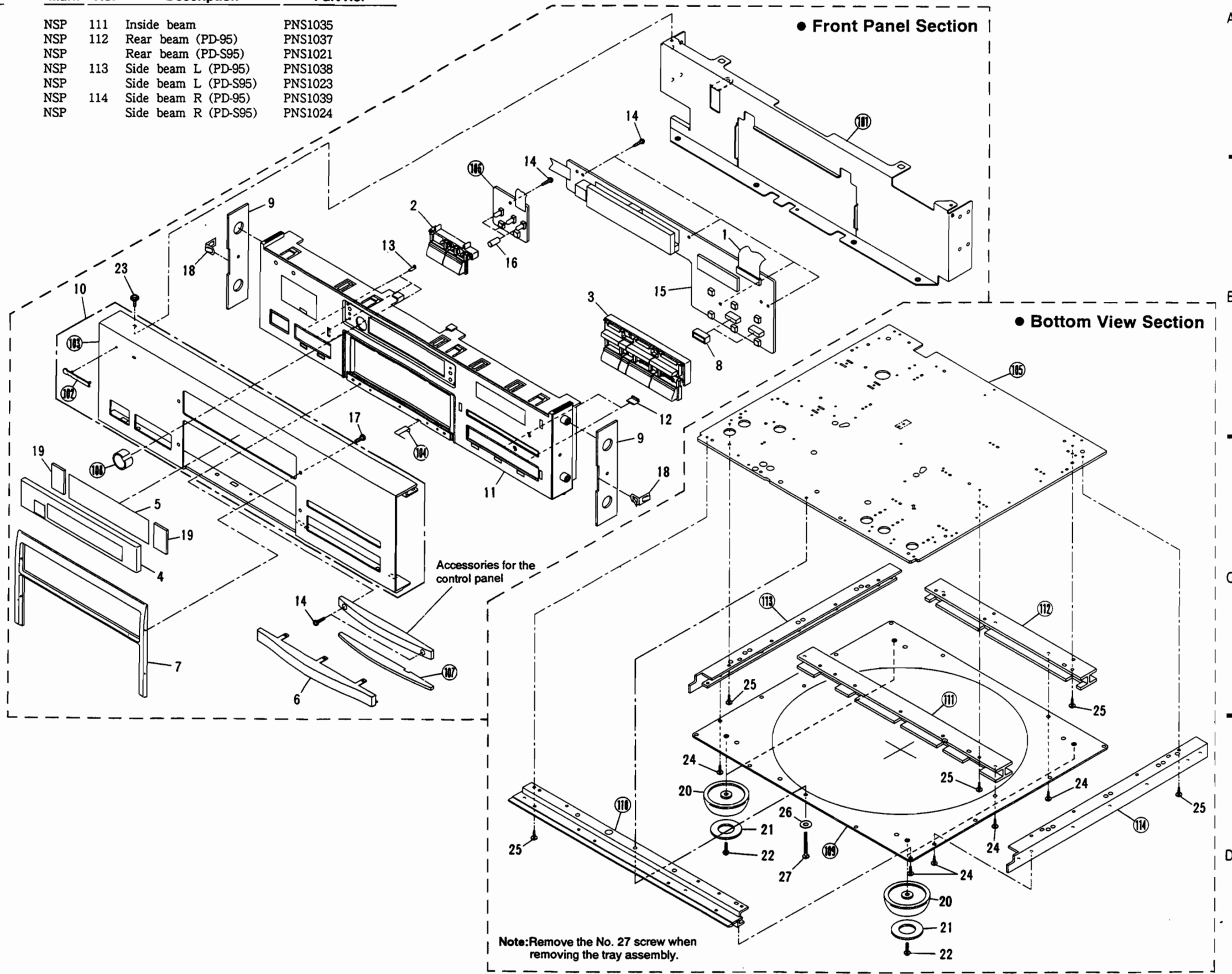
Front Panel Section
(See pages 9-10)

Bottom View Section
(See pages 9-10)

4.2 FRONT PANEL AND BOTTOM VIEW SECTION

Parts List

Mark	No.	Description	Part No.	Mark	No.	Description	Part No.		
A	△	1	23P F.F.C/30V (PD-95)	PDD1069	NSP	111	Inside beam	PNS1035	
	△		25P F.F.C/30V (PD-S95)	PDD1096	NSP	112	Rear beam (PD-95)	PNS1037	
		2	Button	PAC1649	NSP		Rear beam (PD-S95)	PNS1021	
		3	Control button	PAC1619	NSP	113	Side beam L (PD-95)	PNS1038	
		4	Display window	PAM1536	NSP		Side beam L (PD-S95)	PNS1023	
	5	FL sheet (PD-95)	PAM1535	NSP	114	Side beam R (PD-95)	PNS1039		
		FL sheet (PD-S95)	PAM1580	NSP		Side beam R (PD-S95)	PNS1024		
-	6	Display plate (PD-95)	PAN1189						
		Display plate (PD-S95)	PAM1263						
	7	Front mask	PAN1245						
	8	LED cover	PEB1150						
	9	Side rubber	PEB1196						
	10	Front panel assembly (PD-95)	PEA1238						
		Front panel assembly (PD-S95)	PEA1237						
	B	11	Control panel	PNW2076					
		12	Lens L	PNW1860					
		13	Indicator lens	PNW1893					
14		Screw	BBZ26P080FCC						
NSP		15	Operate A board assembly (PD-95)	PWZ1998					
NSP		Operate A board assembly (PD-S95)	PWZ2000						
-	16	LED cover (S)	PEB1167						
	17	Screw	PMA30P080FCU						
	18	Earth plate S	PBK1100						
	19	FL sheet	PNM1149						
	20	Insulator	PLA1097						
NSP	21	Stopper	PNM1156						
	22	Screw	IBZ40P150FCC						
	23	Screw	BBT30P080FCC						
	24	Screw	BBZ40P080FZK						
	25	Screw	IBZ30P080FCC						
C	26	Washer	WC40FCU						
	27	Screw	BBZ40P300FZK						
NSP	101	Front angle	PNB1329						
	102	Name plate	PAN1262						
	103	Front panel (PD-95)	PAN1256						
	104	Front panel (PD-S95)	PAN1257						
	105	Base plate	PNA1711						
NSP	106	Operate B board assembly	PWZ1999						
	107	Absorber (sponge)	PNM1116						
	108	Senser plate	PNM1154						
	109	Under base	PNA1710						
	110	Front beam	PNS1034						



4.3 MECHANISM UNIT

● Installing the Disc Table

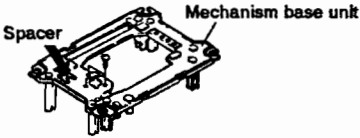


Fig. 1

Cut the spacer indicated by the arrow (Refer to Fig. 1) with a pair of nippers (rear side), insert it between the disc table and mechanism base, and tighten it with a screw.
Torque above 5 kg/cm at this time.
(Reference) : If a torque driver is not available, tighten a hexagonal screw tightly, press down the disc table and check that it does not move downwards.
Remove the spacer after installing the disc table. (Thickness of the spacer is 1 mm.)

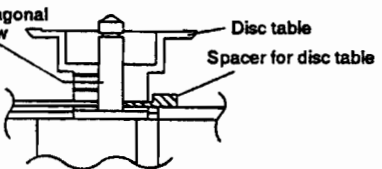
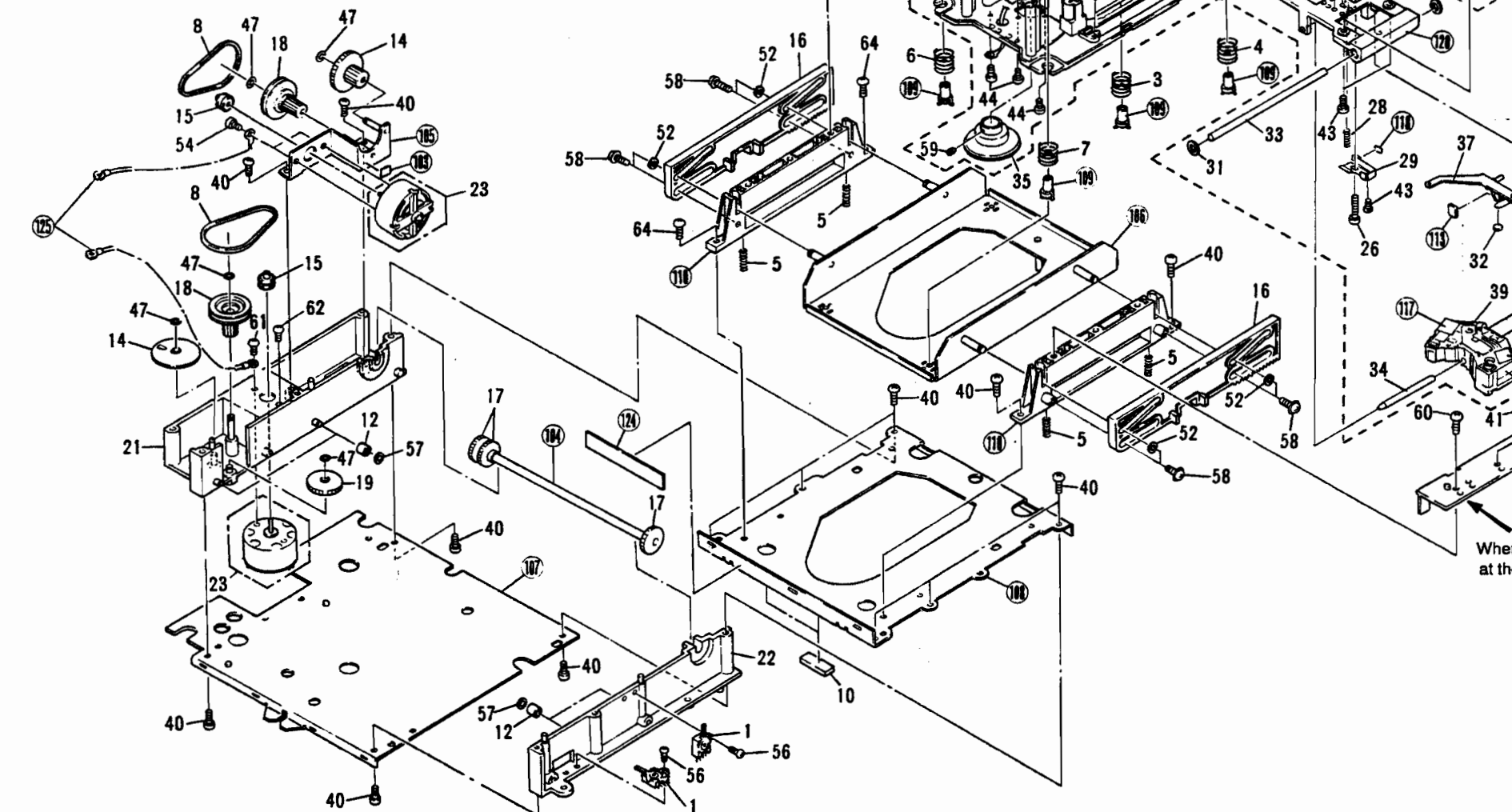
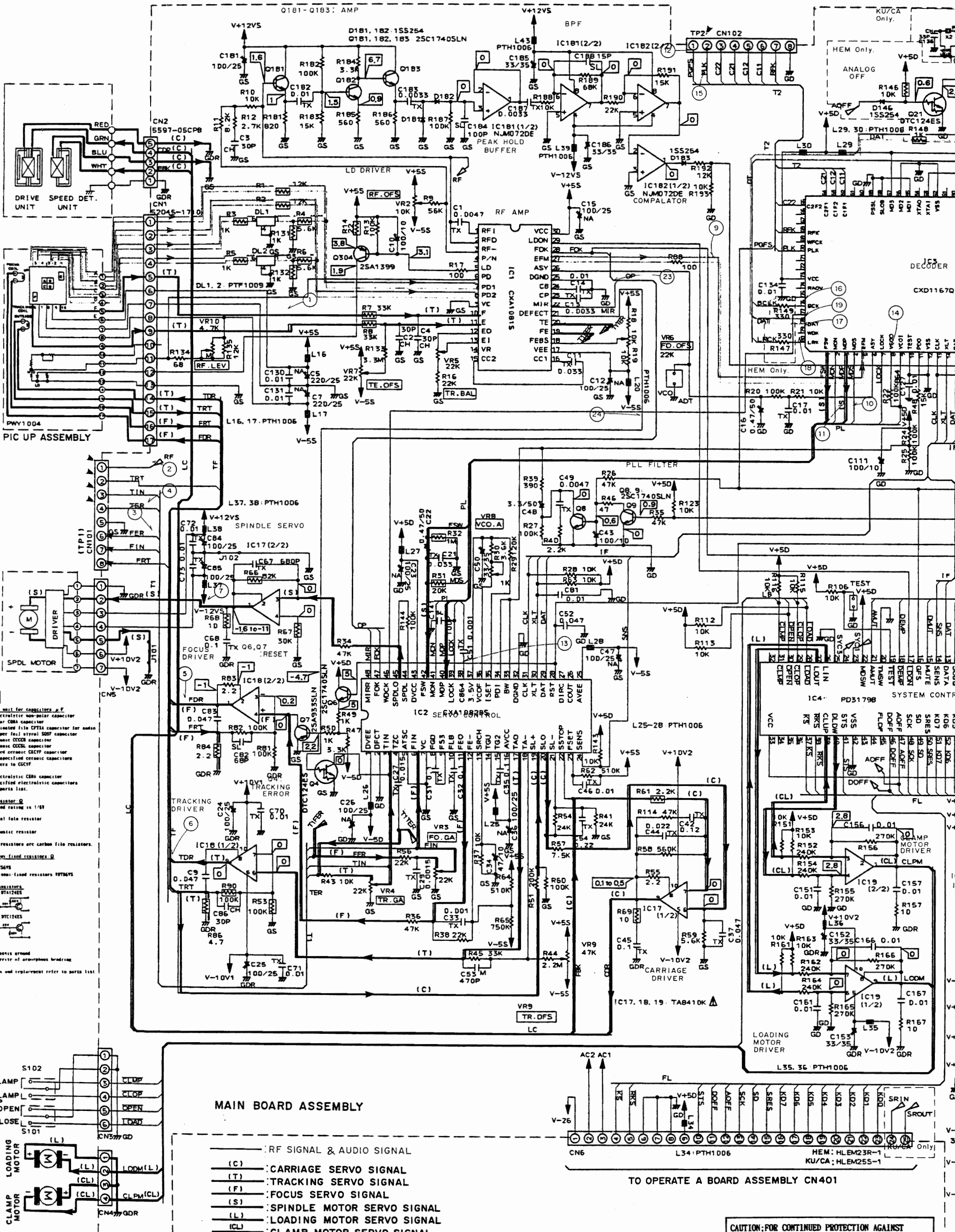


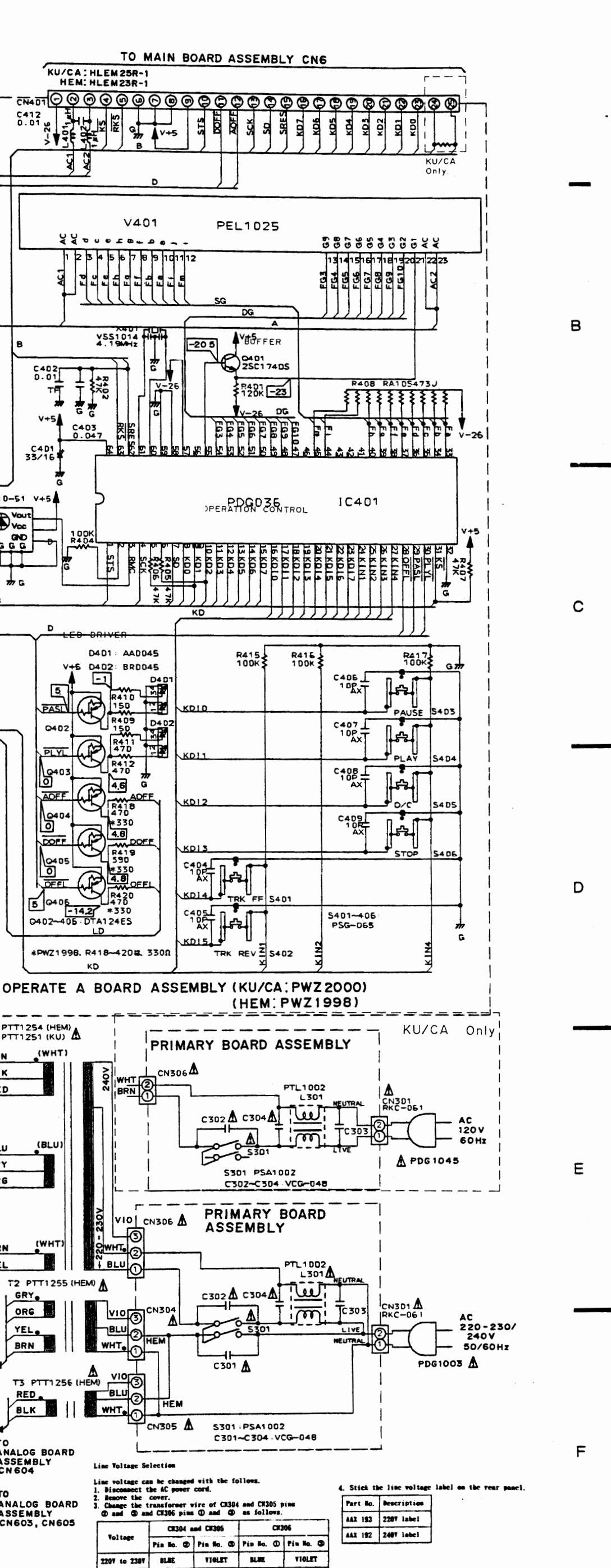
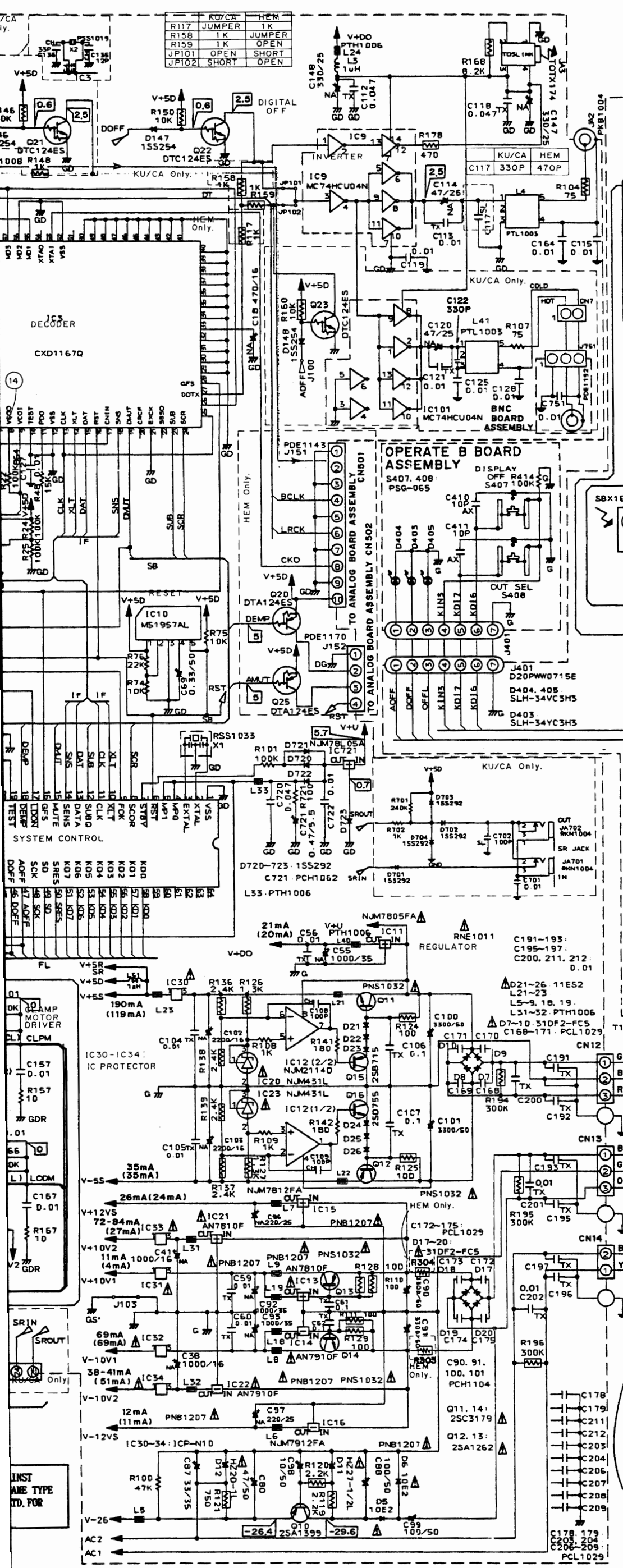
Fig. 2



Pin No.	Volts	Pin No.	Volts	Pin No.	Volts	Pin No.	Volts
IC10 (MS1957AL) (NJM2114D)	1 5.0	IC11 (NJM7805FA)	1 1.6	IC12 (NJM2114D)	1 -2.4	IC13 (AN7810F)	1 17.1
IC10	2 1.6	IC11	2 0.0	IC12	2 -2.5	IC13	2 0.0
IC10	3 0.0	IC11	3 1.3	IC12	3 -2.5	IC13	3 8.5
IC10	4 1.3	IC11	4 -8.5	IC12	4 -8.5	IC13	4 2.5
IC10	5 5.0	IC11	5 2.5	IC12	5 2.5	IC13	5 2.5
IC10	6 2.5	IC11	6 2.5	IC12	6 2.5	IC13	6 2.5
IC10	7 2.4	IC11	7 2.4	IC12	7 2.4	IC13	7 2.4
IC10	8 8.5	IC11	8 8.5	IC12	8 8.5	IC13	8 8.5
IC14 (AN7910F)	1 0.0	IC15 (NJM812FA)	1 17.1	IC16 (NJM7912FA)	1 0.0	IC17 (AN7810F)	1 17.2
IC14	2 -16.5	IC15	2 0.0	IC16	2 0.0	IC17	2 0.0
IC14	3 -10	IC15	3 12	IC16	3 10	IC17	3 10
IC14	Pin No.	IC15	Pin No.	IC16	Pin No.	IC17	Pin No.
IC14	Volts	IC15	Volts	IC16	Volts	IC17	Volts
IC14	1 0.0	IC15	1 17.1	IC16	1 0.0	IC17	1 17.2
IC14	2 -2.5	IC15	2 0.0	IC16	2 0.0	IC17	2 0.0
IC14	3 2.5	IC15	3 10	IC16	3 10	IC17	3 10
IC20 (NJM431L)	1 2.5	IC21 (AN7810F)	1 17.2	IC22 (AN7910F)	1 0.0	IC23 (NJM431L)	1 0.0
IC20	2 0.0	IC21	2 0.0	IC22	2 0.0	IC23	2 -2.5
IC20	3 2.5	IC21	3 10	IC22	3 10	IC23	3 0.0
IC20	Pin No.	IC21	Pin No.	IC22	Pin No.	IC23	Pin No.
IC20	Volts	IC21	Volts	IC22	Volts	IC23	Volts
IC20	1 2.5	IC21	1 17.2	IC22	1 0.0	IC23	1 0.0
IC20	2 0.0	IC21	2 0.0	IC22	2 0.0	IC23	2 -2.5
IC20	3 2.5	IC21	3 10	IC22	3 10	IC23	3 0.0
IC401 (PDG036)	1 1.3 4.9	IC401	2 4.9 5.0	IC401	3 4.9 5.0	IC401	4 4.9 5.0
IC401	5 5.0 3.3	IC401	6 5.0 3.4	IC401	7 5.0 3.4	IC401	8 5.0 3.4
IC401	9 5.0 3.5	IC401	10 5.0 3.5	IC401	11 5.0 3.5	IC401	12 5.0 3.5
IC401	13 5.0 3.6	IC401	14 5.0 3.6	IC401	15 5.0 3.6	IC401	16 5.0 3.6
IC401	17 5.0 3.7	IC401	18 5.0 3.7	IC401	19 5.0 3.7	IC401	20 5.0 3.7
IC401	21 1.3 5.3	IC401	22 5.0 5.4	IC401	23 5.0 5.4	IC401	24 5.0 5.4
IC401	25 1.3 5.2	IC401	26 5.0 5.4	IC401	27 5.0 5.4	IC401	28 5.0 5.4
IC401	29 1.3 5.2	IC401	30 5.0 5.4	IC401	31 5.0 5.4	IC401	32 5.0 5.4
IC401	33 1.3 5.2	IC401	34 5.0 5.4	IC401	35 5.0 5.4	IC401	36 5.0 5.4
IC401	37 1.3 5.2	IC401	38 5.0 5.4	IC401	39 5.0 5.4	IC401	40 5.0 5.4
IC401	41 5.0 5.4	IC401	42 5.0 5.4	IC401	43 5.0 5.4	IC401	44 5.0 5.4
IC401	45 5.0 5.4	IC401	46 5.0 5.4	IC401	47 5.0 5.4	IC401	48 5.0 5.4
IC401	49 5.0 5.4	IC401	50 5.0 5.4	IC401	51 5.0 5.4	IC401	52 5.0 5.4
IC401	53 5.0 5.4	IC401	54 5.0 5.4	IC401	55 5.0 5.4	IC401	56 5.0 5.4
IC401	57 5.0 5.4	IC401	58 5.0 5.4	IC401	59 5.0 5.4	IC401	60 5.0 5.4
IC401	61 5.0 5.4	IC401	62 5.0 5.4	IC401	63 5.0 5.4	IC401	64 5.0 5.4
IC401	65 5.0 5.4	IC401	66 5.0 5.4	IC401	67 5.0 5.4	IC401	68 5.0 5.4
IC401	69 5.0 5.4	IC401	70 5.0 5.4	IC401	71 5.0 5.4	IC401	72 5.0 5.4
IC401	73 5.0 5.4	IC401	74 5.0 5.4	IC401	75 5.0 5.4	IC401	76 5.0 5.4
IC401	77 5.0 5.4	IC401	78 5.0 5.4	IC401	79 5.0 5.4	IC401	80 5.0 5.4
IC401	81 5.0 5.4	IC401	82 5.0 5.4	IC401	83 5.0 5.4	IC401	84 5.0 5.4
IC401	85 5.0 5.4	IC401	86 5.0 5.4	IC401	87 5.0 5.4	IC401	88 5.0 5.4
IC401	89 5.0 5.4	IC401	90 5.0 5.4	IC401	91 5.0 5.4	IC401	92 5.0 5.4
IC401	93 5.0 5.4	IC401	94 5.0 5.4	IC401	95 5.0 5.4	IC401	96 5.0 5.4
IC401	97 5.0 5.4	IC401	98 5.0 5.4	IC401	99 5.0 5.4	IC401	100 5.0 5.4

5. SCHEMATIC AND PCB CONNECTIONS DIAGRAMS





• View from component side

MAIN BOARD ASSEMBLY

#1
IC1 (CXA10815)

No.	Volts	No.	Volts
1	0.0	16	-3.0
2	7.3	17	-5.0
3	0.0	18	0.0
4	2.4	19	0.0
5	2.8	20	0.0
6	-4.8	21	-4.9
7	0.0	22	0.0
8	0.0	23	-1.0
9	0.0	24	-2.1
10	0.0	25	0.0
11	0.0	26	2.5
12	-1.2	27	2.4
13	-0.1	28	5.0
14	0.0	29	0.0
15	-3.1	30	5.0

#2
IC2 (CXA1082B5)

No.	Volts	No.	Volts	No.	Volts
1	-5.0	17	0.0	33	2.5
2	0.0	18	0.0	34	2.5
3	0.0	19	0.0	35	2.3
4	0.0	20	0.0	36	2.3
5	0.0	21	0.0	37	3.5
6	0.0	22	0.0	38	2.4
7	0.0	23	-4.1	39	5.0
8	0.0	24	5.0	40	2.5
9	0.0	25	-5.0	41	5.0
10	0.0	26	0.0	42	2.5
11	0.2	27	5.0	43	5.0
12	0.0	28	5.0	44	0.0
13	0.2	29	5.0	45	2.5
14	0.0	30	5.0	46	2.5
15	0.0	31	5.0	47	5.0
16	5.0	32	0.0	48	0.0

#3
IC3 (CXD11670)

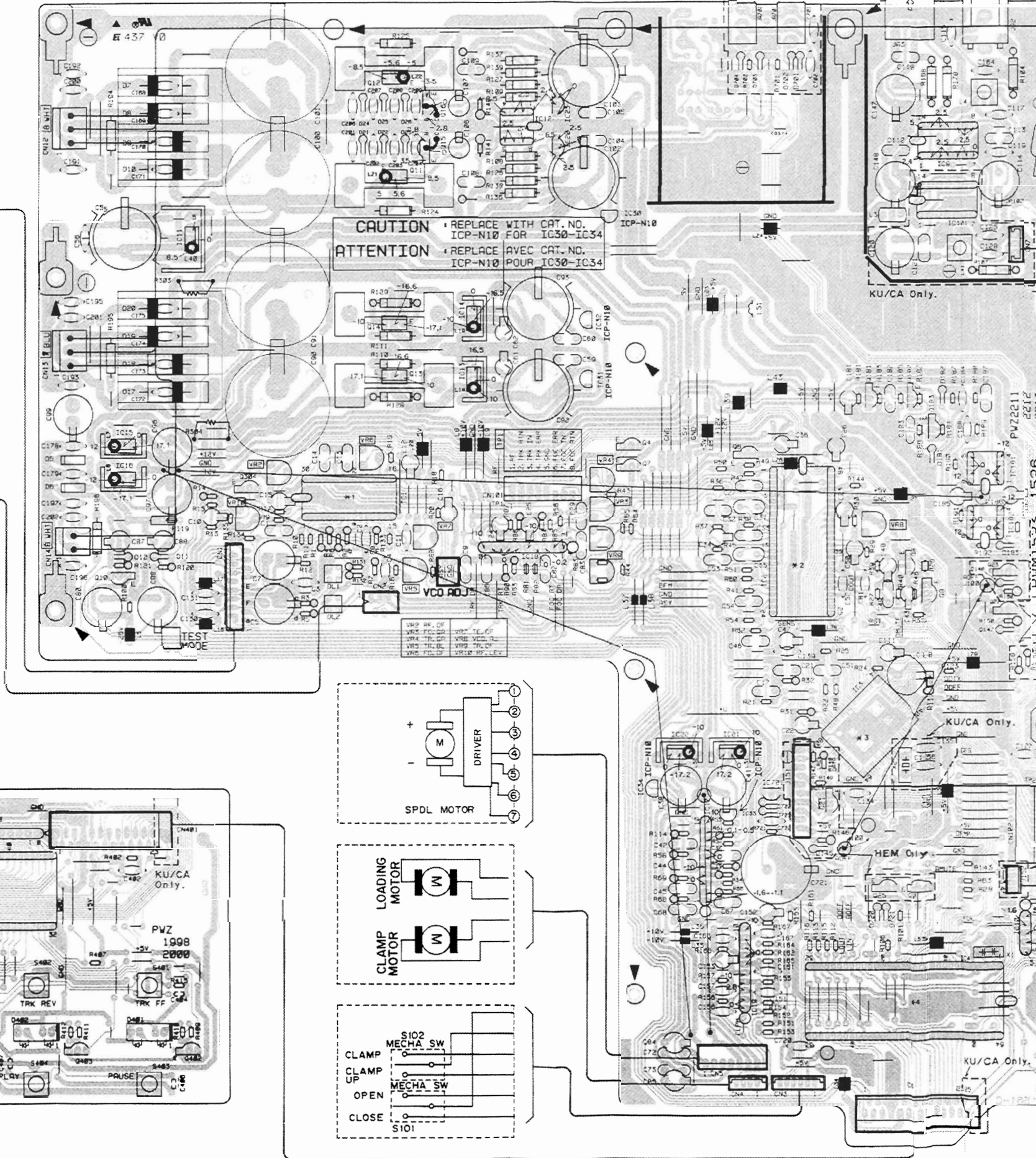
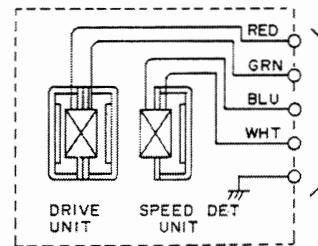
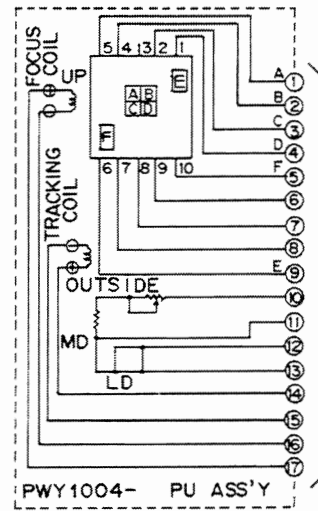
No.	Volts	No.	Volts	No.	Volts	No.	Volts
1	2.5	21	0.0	41	0.0	61	1.3
2	5.0	22	0.0	42	0.0	62	0.0
3	2.5	23	0.0	43	0.0	63	0.9
4	2.8	24	0.0	44	0.0	64	0.9
5	2.4	25	5.0	45	0.0	65	0.0
6	2.5	26	5.0	46	0.0	66	0.0
7	5.0	27	2.5	47	0.0	67	0.0
8	2.4	28	5.0	48	0.0	68	2.5
9	2.4	29	1.9	49	0.0	69	2.5
10	0.0	30	1.9	50	0.0	70	2.3
11	0.0	31	0.0	51	0.0	71	0.0
12	0.0	32	0.0	52	0.0	72	0.0
13	5.0	33	5.0	53	2.2	73	5.0
14	5.0	34	0.0	54	2.2	74	0.0
15	5.0	35	0.0	55	0.0	75	2.4
16	5.0	36	0.0	56	0.0	76	2.3
17	0.0	37	0.0	57	5.0	77	2.2
18	5.0	38	0.0	58	0.0	78	2.5
19	0.0	39	0.0	59	0.0	79	2.5
20	5.0	40	0.0	60	1.2	80	2.5

#4
IC4 (PD31798)

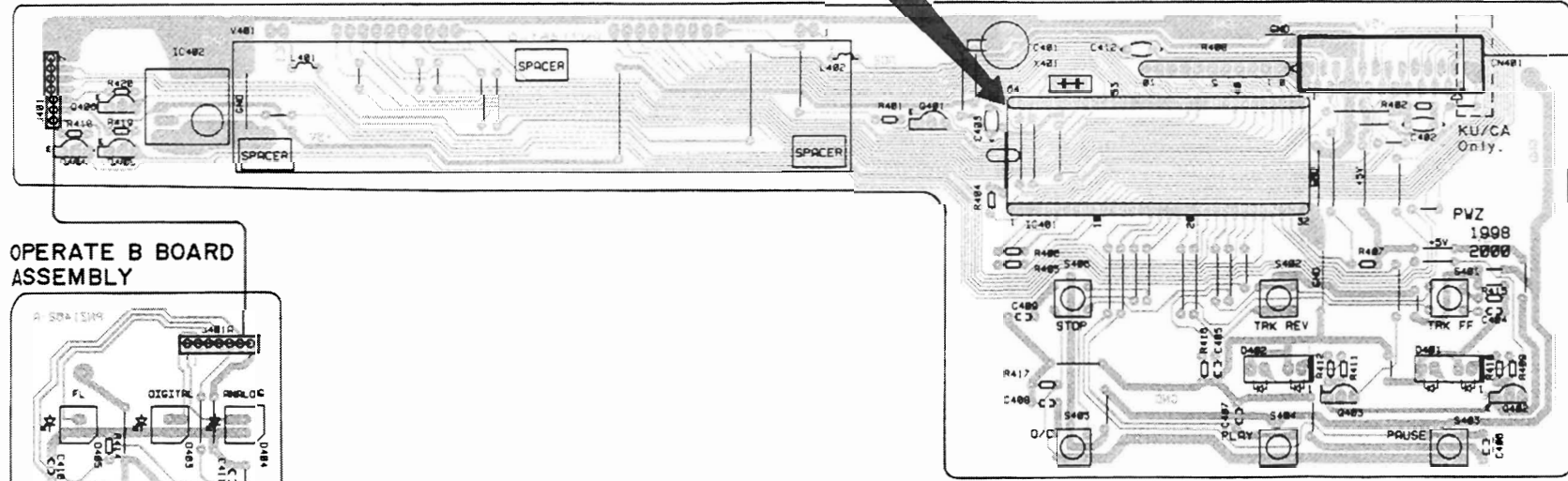
No.	Volts	No.	Volts	No.	Volts	No.	Volts
1	0.0	17	0.0	32	5.0	49	17.1
2	1.5	18	5.0	34	5.0	50	5.0
3	2.1	19	5.0	35	0.0	51	0.0
4	5.0	20	0.0	36	5.0	52	0.0
5	5.0	21	0.0	37	5.0	53	0.0
6	5.0	22	5.0	38	5.0	54	0.0
7	5.4	23	4.9	39	0.0	55	0.0
8	0.0	24	5.0	40	0.0	56	0.0
9	5.0	25	0.0	41	13.1	57	0.0
10	5.0	26	0.0	42	0.0	58	0.0
11	5.0	27	0.0	43	0.0	59	0.0
12	1.1	28	0.0	44	0.0	60	0.0
13	5.0	29	4.9	45	0.0	61	0.0
14	5.0	30	4.9	46	0.0	62	2.5
15	0.0	31	0.0	47	0.0	63	0.0
16	5.0	32	0.0	48	5.0	64	2.5

IC401 (PDG036)

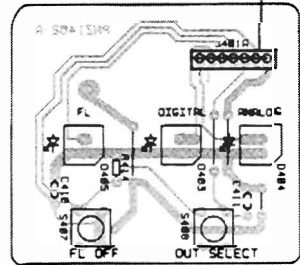
No.	Volts	No.	Volts	No.	Volts	No.	Volts
1	1.1	14	1.7	5.0	3.2	1.3	4.9
2	0.0	18	5.0	3.4	4.9	5.0	-12.1
3	4.9	19	5.0	3.5	4.9	5.1	-12.1
4	4.9	20	5.0	3.6	1.3	5.2	-12.1
5	5.1	21	5.0	3.7	1.3	5.3	-12.1
6	0.0	22	5.0	3.8	5.0	5.4	-12.1
7	1.1	23	5.0	3.9	-12.1	5.5	-12.1
8	0.0	24	0.0	4.0	-12.1	5.6	-12.1
9	0.0	25	0.0	4.1	5.1	5.7	-2.6
10	0.0	26	0.0	4.2	0.6	5.8	0.0
11	0.0	27	0.0	4.2	5.0	5.9	0.0
12	0.0	28	5.0	4.4	-12.1	6.0	2.3
13	0.0	29	5.0	4.5	1.6	6.1	2.2
14	0.0	30	0.0	4.6	-12.1	6.2	5.0
15	0.0	31	0.0	4.7	-12.1	6.3	5.0
16	5.0	32	0.0	4.8	-12.1	6.4	5.0

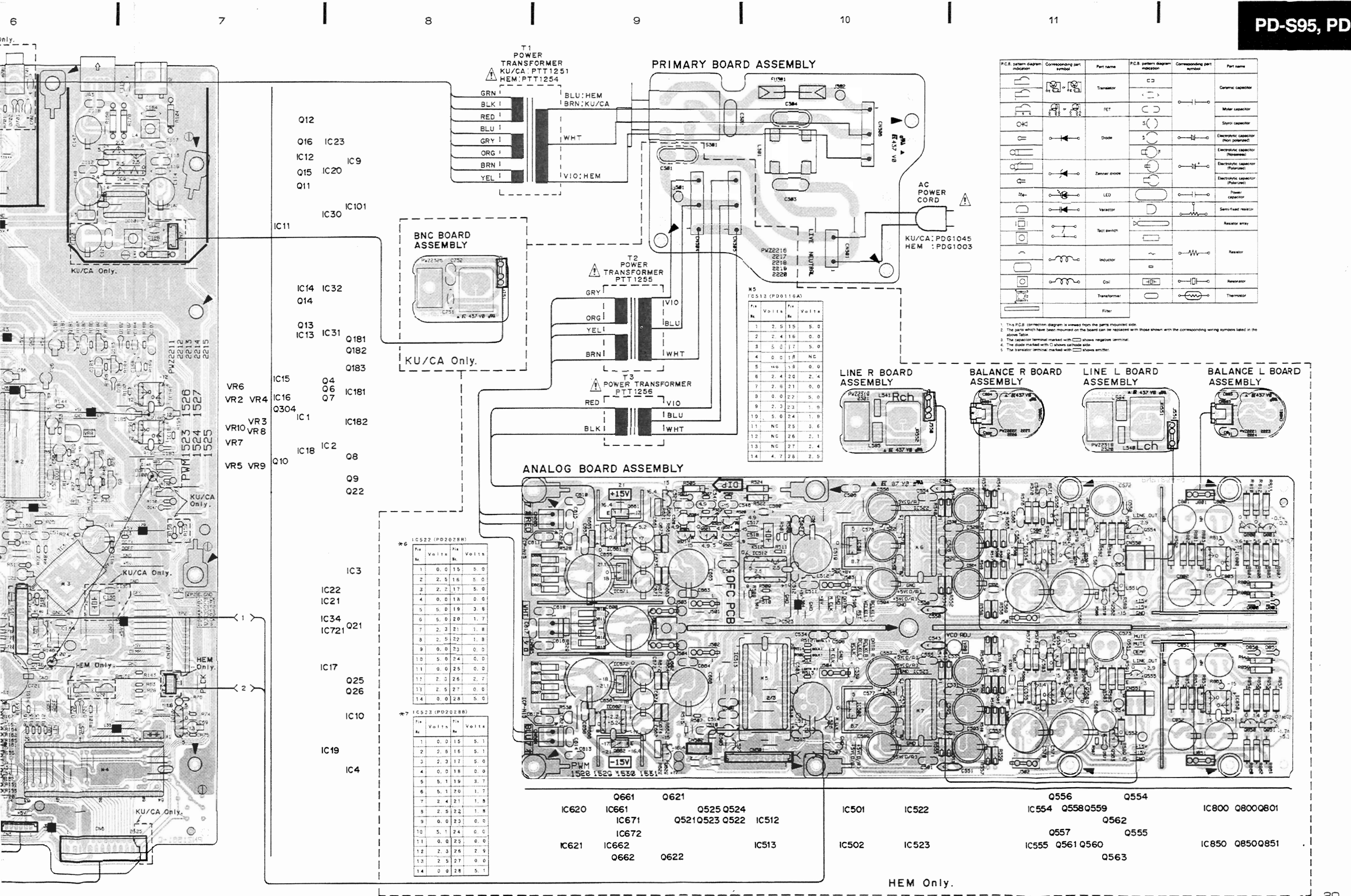


OPERATE A BOARD ASSEMBLY



OPERATE B BOARD ASSEMBLY





P.C.B. pattern diagram indication	Corresponding part symbol	Part name	P.C.B. pattern diagram indication	Corresponding part symbol	Part name
		Transistor			Ceramic capacitor
		ICF			Mylar capacitor
		Diode			Synov capacitor
		Zener diode			Electrolytic capacitor (Non polarized)
		LED			Electrolytic capacitor (Polarized)
		Varactor			Fuse capacitor
		Tact switch			Semi-fixed resistor
		Inductor			Resistor
		Coil			Resistor
		Transformer			Thermistor
		Filter			

1. This P.C.B. correction diagram is viewed from the parts mounted side.
 2. The parts which have been mounted on the board can be replaced with those shown with the corresponding wiring symbols listed in the above table.
 3. The capacitor terminal marked with ⊖ shows negative terminal.
 4. The diode marked with ⊕ shows cathode side.
 5. The transistor terminal marked with ⊕ shows emitter.

IC522 (PD20288)

No.	Volts	No.	Volts
1	0.0	15	5.0
2	2.5	16	5.0
3	2.2	17	5.0
4	0.0	18	0.0
5	5.0	19	3.8
6	5.0	20	1.7
7	2.3	21	1.8
8	2.5	22	1.8
9	0.0	23	0.0
10	5.0	24	0.0
11	0.0	25	0.0
12	2.3	26	2.7
13	2.5	27	0.0
14	0.0	28	5.0

IC523 (PD20288)

No.	Volts	No.	Volts
1	0.0	15	5.1
2	2.5	16	5.1
3	2.3	17	5.0
4	0.0	18	0.0
5	5.1	19	3.7
6	5.1	20	1.7
7	2.4	21	1.8
8	2.5	22	1.8
9	0.0	23	0.0
10	5.1	24	0.0
11	0.0	25	0.0
12	2.3	26	2.9
13	2.5	27	0.0
14	0.0	28	5.1

- Q661 Q621 Q525 Q524 Q556 Q554
- IC620 IC661 Q525 Q524 IC501 IC522 IC554 Q558 Q559 Q554
- IC661 IC671 Q521 Q523 Q522 IC512 Q562
- IC672 IC672 IC513 IC502 IC523 Q557 Q555
- Q662 Q622 IC513 IC502 IC523 IC555 Q561 Q560 Q563
- IC800 Q800 Q801 IC850 Q850 Q851

HEM Only.

A

B

C

D

L

12

13

11

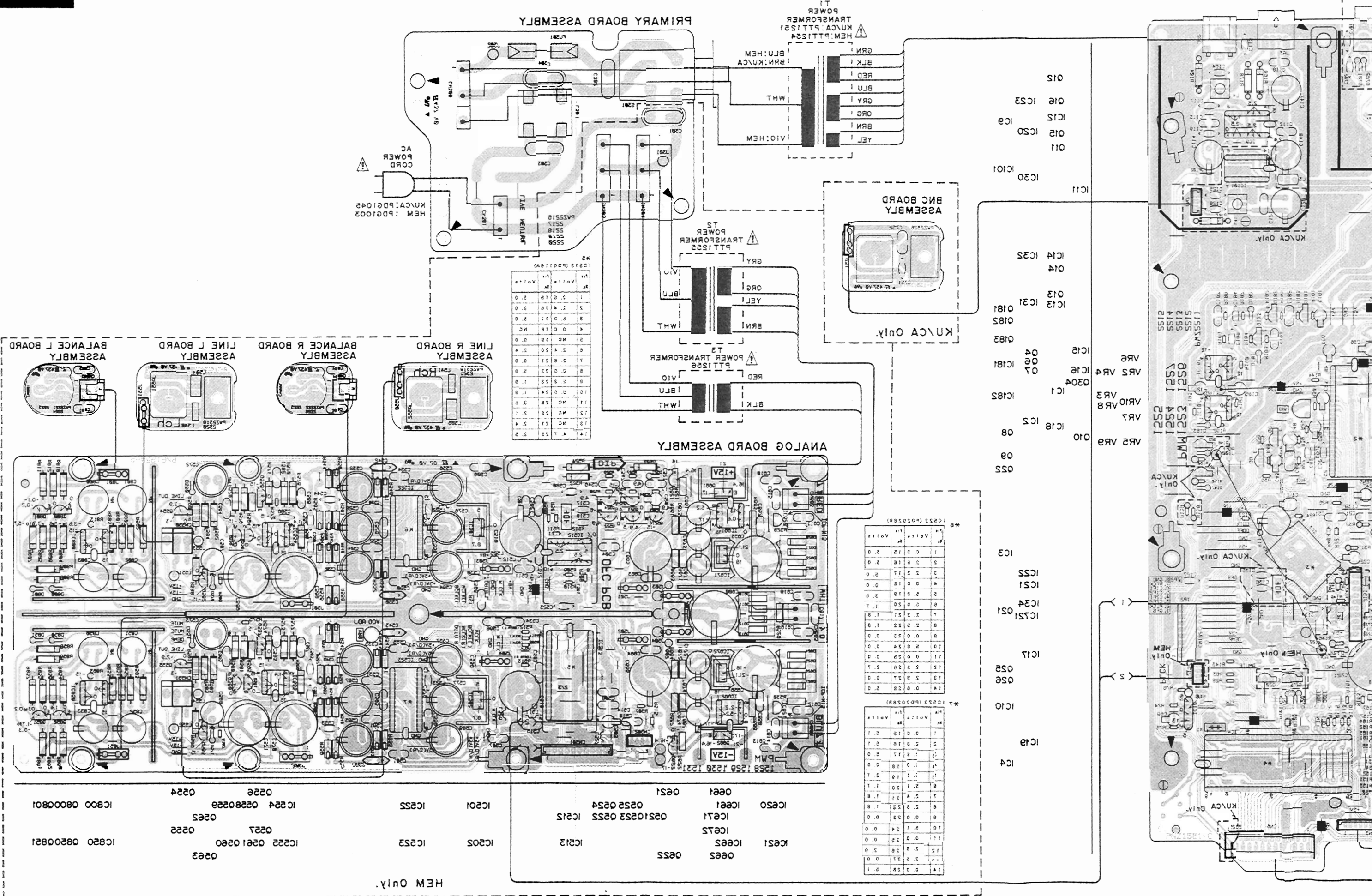
10

9

8

7

6



7

A

B

C

D

View from soldering side

Pin	Volts	Pin	Volts
1	0.00	11	0.00
2	0.00	12	0.00
3	0.00	13	0.00
4	0.00	14	0.00
5	0.00	15	0.00
6	0.00	16	0.00
7	0.00	17	0.00
8	0.00	18	0.00
9	0.00	19	0.00
10	0.00	20	0.00
11	0.00	21	0.00
12	0.00	22	0.00
13	0.00	23	0.00
14	0.00	24	0.00
15	0.00	25	0.00
16	0.00	26	0.00
17	0.00	27	0.00
18	0.00	28	0.00
19	0.00	29	0.00
20	0.00	30	0.00

Pin	Volts	Pin	Volts
1	0.00	11	0.00
2	0.00	12	0.00
3	0.00	13	0.00
4	0.00	14	0.00
5	0.00	15	0.00
6	0.00	16	0.00
7	0.00	17	0.00
8	0.00	18	0.00
9	0.00	19	0.00
10	0.00	20	0.00
11	0.00	21	0.00
12	0.00	22	0.00
13	0.00	23	0.00
14	0.00	24	0.00
15	0.00	25	0.00
16	0.00	26	0.00
17	0.00	27	0.00
18	0.00	28	0.00
19	0.00	29	0.00
20	0.00	30	0.00

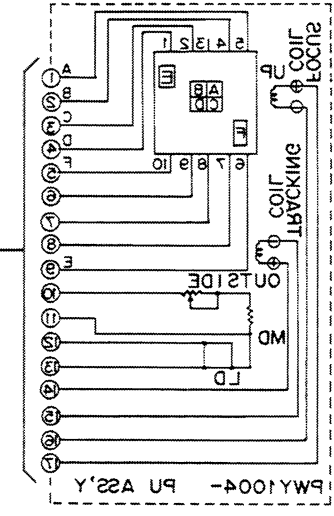
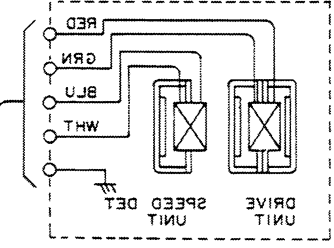
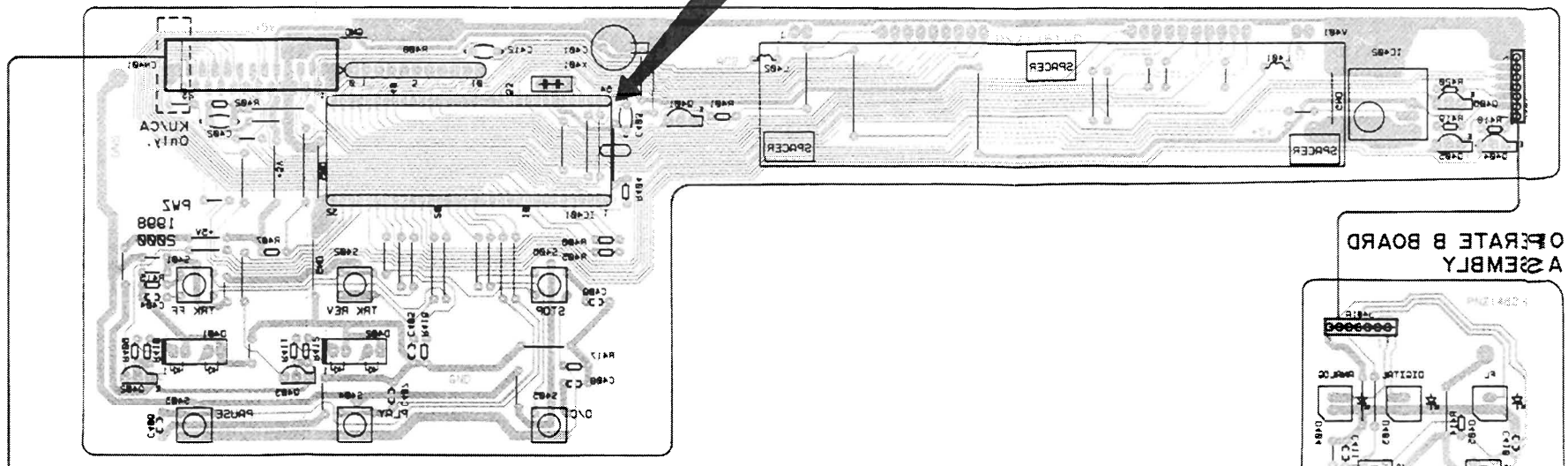
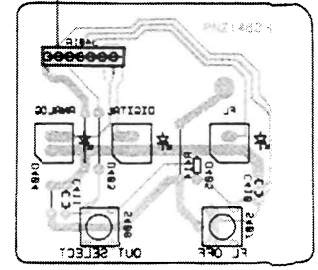
Pin	Volts	Pin	Volts
1	0.00	11	0.00
2	0.00	12	0.00
3	0.00	13	0.00
4	0.00	14	0.00
5	0.00	15	0.00
6	0.00	16	0.00
7	0.00	17	0.00
8	0.00	18	0.00
9	0.00	19	0.00
10	0.00	20	0.00
11	0.00	21	0.00
12	0.00	22	0.00
13	0.00	23	0.00
14	0.00	24	0.00
15	0.00	25	0.00
16	0.00	26	0.00
17	0.00	27	0.00
18	0.00	28	0.00
19	0.00	29	0.00
20	0.00	30	0.00

Pin	Volts	Pin	Volts
1	0.00	11	0.00
2	0.00	12	0.00
3	0.00	13	0.00
4	0.00	14	0.00
5	0.00	15	0.00
6	0.00	16	0.00
7	0.00	17	0.00
8	0.00	18	0.00
9	0.00	19	0.00
10	0.00	20	0.00
11	0.00	21	0.00
12	0.00	22	0.00
13	0.00	23	0.00
14	0.00	24	0.00
15	0.00	25	0.00
16	0.00	26	0.00
17	0.00	27	0.00
18	0.00	28	0.00
19	0.00	29	0.00
20	0.00	30	0.00

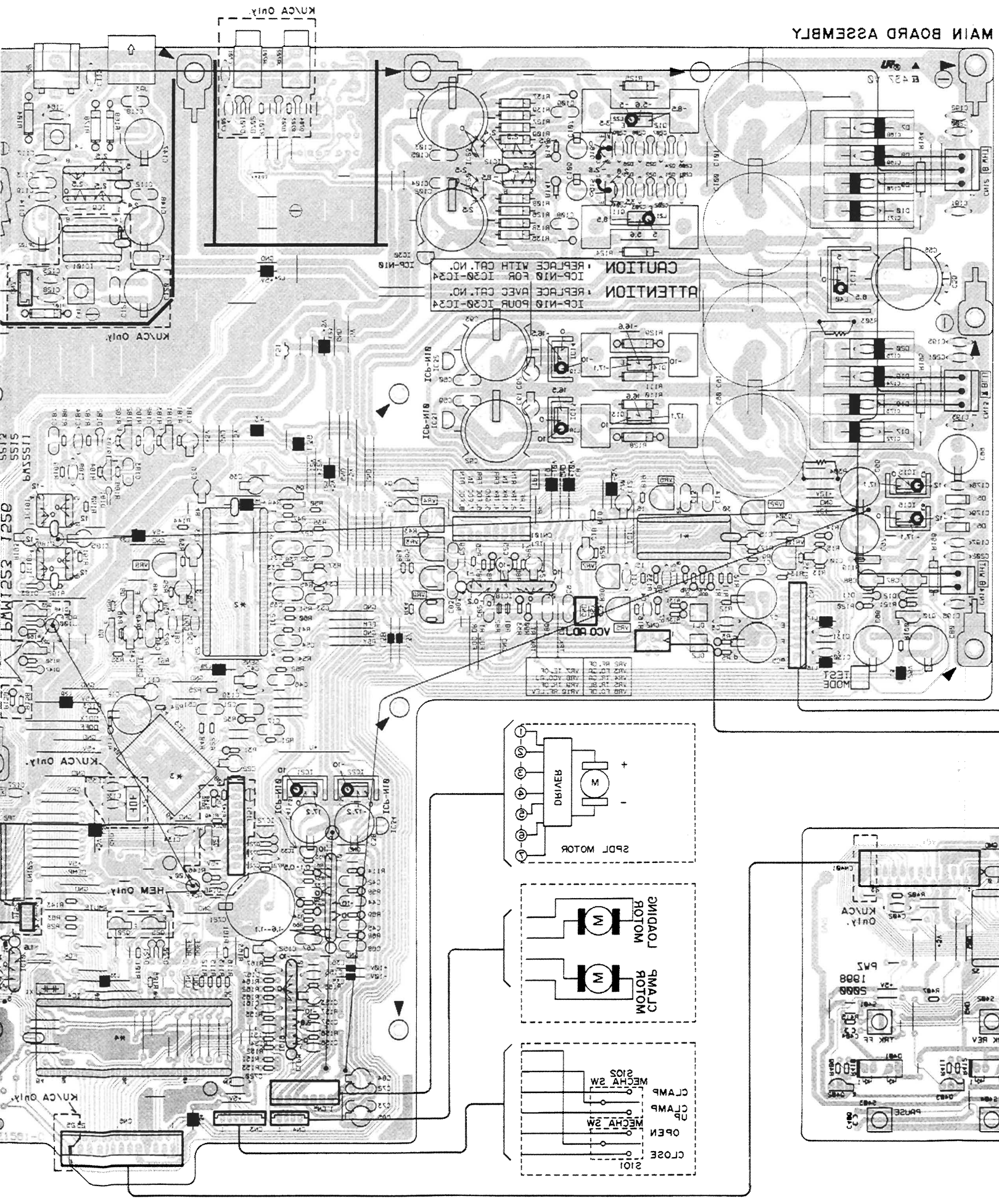
Pin	Volts	Pin	Volts
1	0.00	11	0.00
2	0.00	12	0.00
3	0.00	13	0.00
4	0.00	14	0.00
5	0.00	15	0.00
6	0.00	16	0.00
7	0.00	17	0.00
8	0.00	18	0.00
9	0.00	19	0.00
10	0.00	20	0.00
11	0.00	21	0.00
12	0.00	22	0.00
13	0.00	23	0.00
14	0.00	24	0.00
15	0.00	25	0.00
16	0.00	26	0.00
17	0.00	27	0.00
18	0.00	28	0.00
19	0.00	29	0.00
20	0.00	30	0.00

OPERATE A BOARD ASSEMBLY

OPERATE B BOARD ASSEMBLY

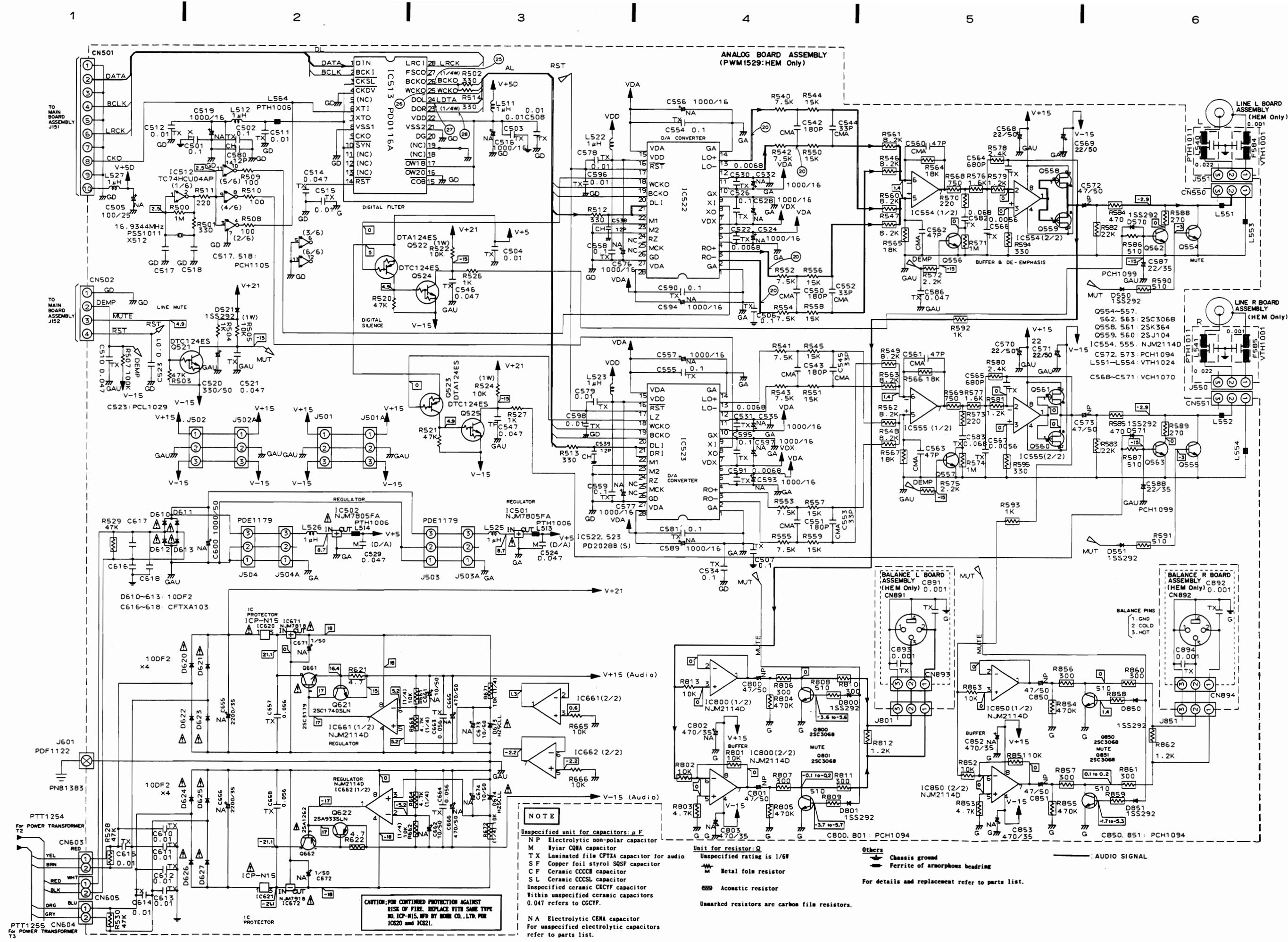


MAIN BOARD ASSEMBLY



1 2 3 4 5 6

1 2 3 4 5 6



1. RESISTORS :

Indicated in Ω , 1/4W, 1/6W, 1/8W, $\pm 5\%$ tolerance unless otherwise noted k ; k Ω , M ; M Ω , (F) ; $\pm 1\%$, (G) ; $\pm 2\%$, (K) ; $\pm 10\%$, (M) ; $\pm 20\%$ tolerance.

2. CAPACITORS :

Indicated in capacity (μ F) /voltage (V) unless otherwise noted p ; pF. Indication without voltage is 50V except electrolytic capacitor.

3. VOLTAGE CURRENT :

\square ; DC voltage (V) in play mode.

\leftarrow mA ; DC current in play mode.

; Value in () is DC current in stop mode.

4. OTHERS :

\rightarrow ; Signal route.

\otimes ; Adjusting point

The Δ mark found on some component parts indicates the importance of the safety factor of the part. Therefore, when replacing, be sure to use parts of identical designation.

* marked capacitors and resistors have parts numbers.

This is the basic schematic diagram, but the actual circuit may vary due to improvements in design.

5. SWITCHES (The underlined indicates the switch position)

PRIMARY BOARD ASSEMBLY
S301 : POWER ON - OFF

OPERATE A BOARD ASSEMBLY

S401 : TRK FF
S402 : TRK REV
S403 : PAUSE
S404 : PLAY
S405 : O/C
S406 : STOP

OPERATE B BOARD ASSEMBLY
S407 : DISPLAY OFF
S408 : OUT SEL

IC513 (PD0116A)

Pin No.	Volts	Pin No.	Volts
1	2.5	15	5.0
2	2.4	16	0.0
3	5.0	17	5.0
4	0.0	18	NC
5	NC	19	0.0
6	2.4	20	2.4
7	2.6	21	0.0
8	0.0	22	5.0
9	2.3	23	1.9
10	5.0	24	1.9
11	NC	25	3.6
12	NC	26	2.1
13	NC	27	2.4
14	4.7	28	2.5

IC522 (PD2028B)

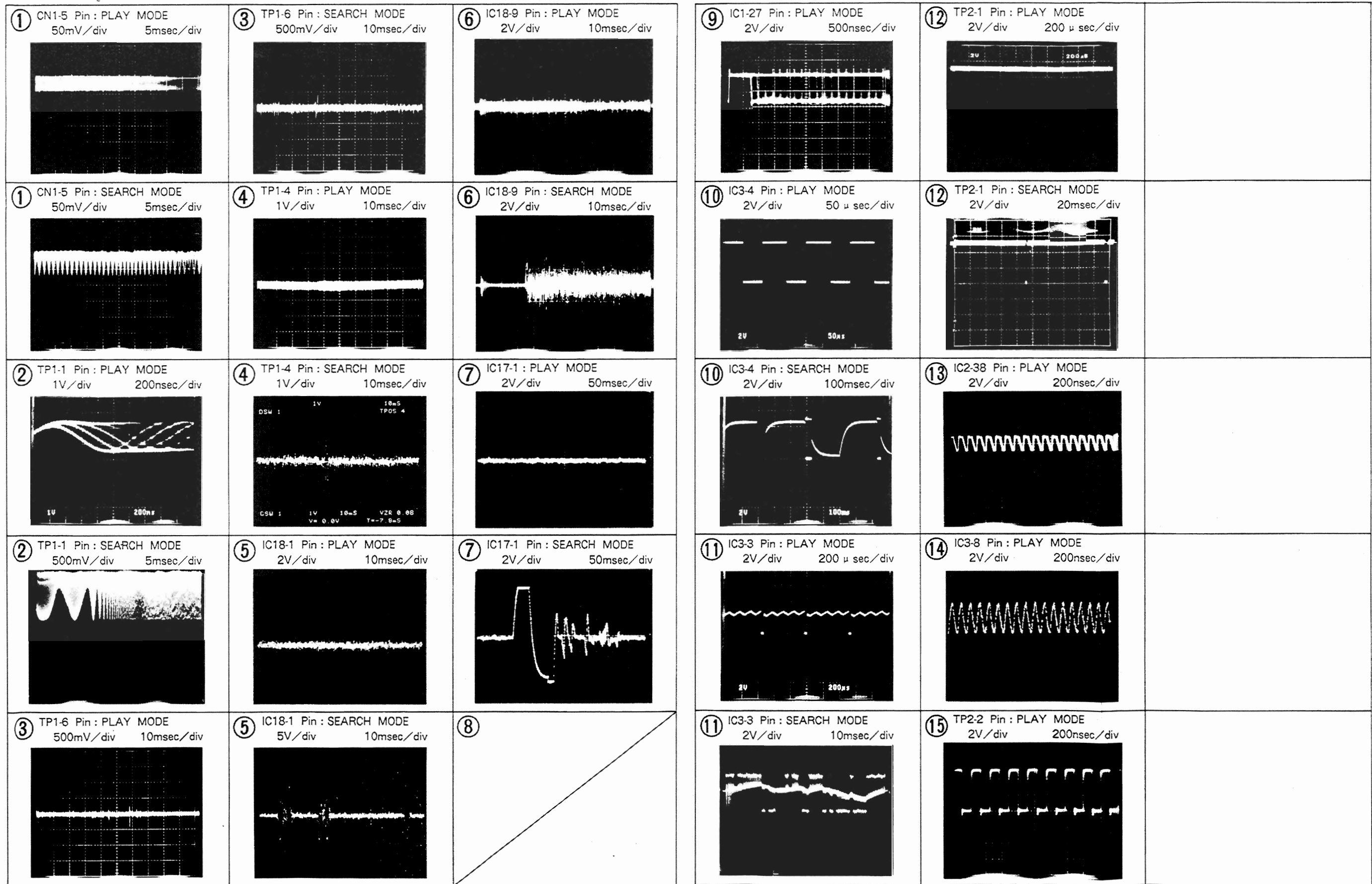
Pin No.	Volts	Pin No.	Volts
1	0.0	15	5.0
2	2.5	16	5.0
3	2.2	17	5.0
4	0.0	18	0.0
5	5.0	19	3.6
6	5.0	20	1.7
7	2.3	21	1.8
8	2.5	22	1.8
9	0.0	23	0.0
10	5.0	24	0.0
11	0.0	25	0.0
12	2.3	26	2.7
13	2.5	27	0.0
14	0.0	28	5.0

IC523 (PD2028B)

Pin No.	Volts	Pin No.	Volts
1	0.0	15	5.1
2	2.6	16	5.1
3	2.3	17	5.0
4	0.0	18	0.0
5	5.1	19	3.7
6	5.1	20	1.7
7	2.4	21	1.8
8	2.5	22	1.8
9	0.0	23	0.0
10	5.1	24	0.0
11	0.0	25	0.0
12	2.3	26	2.9
13	2.5	27	0.0
14	0.0	28	5.1

Waveforms

Note: The encircled numbers denote measuring points in the schematic diagram.



①⑥ ①⑦ ①⑧ ①⑨

IC3 (CXD1167Q)

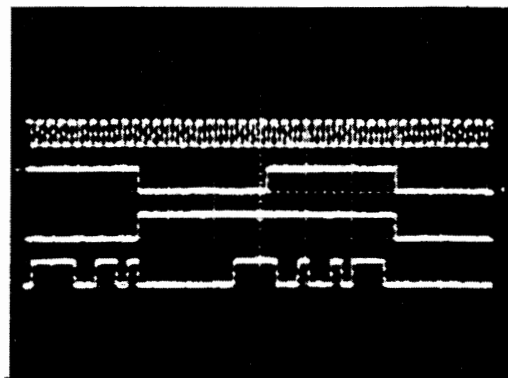
PLAY MODE

①⑥ BCLK (Pin76)

①⑦ WDCK (Pin79)

①⑧ LRCK (Pin80)

①⑨ DATA (Pin78)

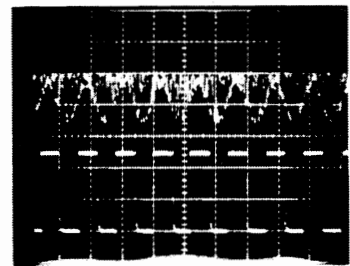


10V/div
2 μ sec/div

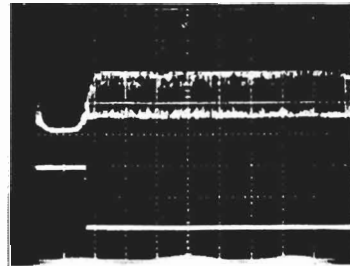
②⑩ IC522, IC523 - 13, 12, 2, 3 Pin :
PLAY MODE (0dB, 1kHz)
2V/div 200 μ sec/div



②③ IC1-22 Pin : TRACKING OPEN
0.1msec/div
Upper TP1-1 Pin : 1V/div
Lower IC1-22 Pin : 2V/div



②④ IC1-21 Pin : DFCT 0.5msec/div
Upper TP1-1 Pin : 1V/div
Lower IC1-21 Pin : 5V/div



②⑤ ②⑥ ②⑦ ②⑧

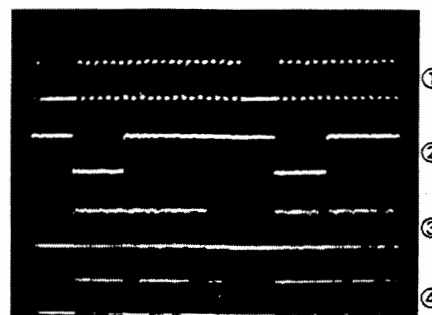
IC513 PD0116A
PLAY MODE
5V/div.

②⑤ BCKO (Pin26)

②⑥ WCKO (Pin25)

②⑦ DOL (Pin24)

②⑧ DOR (Pin23)



①
②
③
④

6. PCB PARTS LIST

NOTES:

- Parts marked by "NSP" are generally unavailable because they are not in our Master Spare Parts List.
- Parts marked by "⊙" are not always kept in stock. Their delivery time may be longer than usual or they may be unavailable.
- The Δ mark found on some component parts indicates the importance of the safety factor of the part. Therefore, when replacing, be sure to use parts of identical designation.
- When ordering resistors, first convert resistance values into code form as shown in the following examples.

Ex.1 When there are 2 effective digits (any digit apart from 0), such as 560 ohm and 47k ohm (tolerance is shown by J=5%, and K=10%)

560 Ω \rightarrow $56 \times 10^1 \rightarrow 561$ RD1/4PS $\begin{matrix} 5 & 6 & 1 \\ \hline & & \end{matrix}$ J
 47k Ω \rightarrow $47 \times 10^3 \rightarrow 473$ RD1/4PS $\begin{matrix} 4 & 7 & 3 \\ \hline & & \end{matrix}$ J
 0.5 Ω \rightarrow 0R5 RN2H $\begin{matrix} 0 & R & 5 \\ \hline & & \end{matrix}$ K
 1 Ω \rightarrow 010 RS1P $\begin{matrix} 0 & 1 & 0 \\ \hline & & \end{matrix}$ K

Ex.2 When there are 3 effective digits (such as in high precision metal film resistors).

5.62k Ω \rightarrow $562 \times 10^1 \rightarrow 5621$ RN1/4SR $\begin{matrix} 5 & 6 & 2 & 1 \\ \hline & & & \end{matrix}$ F

Mark	No.	Description	Part No.	Mark	No.	Description	Part No.
LIST OF ASSEMBLIES							
PD-S95							
⊙		SUB BOARD ASSEMBLY	PWM1363		Q524, 525	TRANSISTOR	DTC124ES
NSP	└	OPERATE B BOARD ASSEMBLY	PWZ1999		Q554-557	TRANSISTOR	2SC3068
NSP		OPERATE A BOARD ASSEMBLY	PWZ2000		Q558		2SK364
⊙		MOTHER BOARD ASSEMBLY	PWM1525		Q559, 560	FET	2SJ104
NSP	└	MAIN BOARD ASSEMBLY	PWZ2213		Q561		2SK364
NSP		PRIMARY BOARD ASSEMBLY	PWZ2218		Q562, 563	TRANSISTOR	2SC3068
NSP	└	BNC BOARD ASSEMBLY	PWZ2326		Q621	TRANSISTOR	2SC1740SLN
PD-95					Q622	TRANSISTOR	2SA933SLN
⊙		SUB BOARD ASSEMBLY	PWM1362	Δ	Q661	TRANSISTOR	2SC3179
NSP	└	OPERATE B BOARD ASSEMBLY	PWZ1999	Δ	Q662	TRANSISTOR	2SA1262
NSP		OPERATE A BOARD ASSEMBLY	PWZ1998		Q800, 801	TRANSISTOR	2SC3068
⊙		MOTHER BOARD ASSEMBLY	PWM1524		Q850, 851	TRANSISTOR	2SC3068
NSP	└	MAIN BOARD ASSEMBLY	PWZ2212		D521	DIODE	1SS292
NSP		PRIMARY BOARD ASSEMBLY	PWZ2217		D550, 551	DIODE	1SS292
NSP	└	BALLANCE L BOARD ASSEMBLY	PWZ2223	Δ	D570, 571	DIODE	1SS292
NSP	└	BALLANCE R BOARD ASSEMBLY	PWZ2225	Δ	D610-613	DIODE	10DF2
NSP	└	LINE L BOARD ASSEMBLY	PWZ2320	Δ	D620-627	DIODE	10DF2
NSP	└	LINE R BOARD ASSEMBLY	PWZ2321		D673, 674	ZENER DIODE	HZ5CLL
⊙		ANALOG BOARD ASSEMBLY	PWM1529		D800, 801	DIODE	1SS292
					D850, 851	DIODE	1SS292
				COILS/TRANSFORMERS			
					L511, 512	AXIAL INDUCTOR	LAU010K
					L513, 514		PTH1006
					L522, 523	AXIAL INDUCTOR	LAU010K
					L525-527	AXIAL INDUCTOR	LAU010K
					L551-554	FERRITE BEAD	VTH1024
					L564		PTH1006
				CAPACITORS			
					C501, 502	AUDIO FILM CAPACITOR	CFTXA104J50
					C503, 504	AUDIO FILM CAPACITOR	CFTXA103J50
					C505	ELECT. CAPACITOR	CENA101M25
					C506, 507	AUDIO FILM CAPACITOR	CFTXA104J50
					C508	AUDIO FILM CAPACITOR	CFTXA103J50
					C510	AUDIO FILM CAPACITOR	CFTXA473J50
					C511, 512	AUDIO FILM CAPACITOR	CFTXA103J50
					C514	AUDIO FILM CAPACITOR	CFTXA473J50
					C515	AUDIO FILM CAPACITOR	CFTXA103J50
					C516	ELECT. CAPACITOR	CENA102M16
					C517, 518 (12P/100)		PCH1105
SEMICONDUCTORS							
		IC501, 502 REGULATOR IC	NJM7805FA				
		IC512 LOGIC IC	TC74HCU04AP				
		IC513 IC	PD0116A				
		IC522, 523 D/A CONVERTER IC	PD2028B				
		IC554, 555 OP-AMP IC	NJM2114D				
Δ		IC620, 621 IC PROTECTOR	ICP-N15				
		IC661, 662 OP-AMP IC	NJM2114D				
Δ		IC671 REGULATOR IC	NJM7818FA				
Δ		IC672 REGULATOR IC	NJM7918FA				
		IC800 OP-AMP IC	NJM2114D				
		IC850 OP-AMP IC	NJM2114D				
		Q521 TRANSISTOR	DTC124ES				
		Q522, 523 TRANSISTOR	DTA124ES				

ANALOG BOARD ASSEMBLY (PD-95 only)

SEMICONDUCTORS

		IC501, 502 REGULATOR IC	NJM7805FA
		IC512 LOGIC IC	TC74HCU04AP
		IC513 IC	PD0116A
		IC522, 523 D/A CONVERTER IC	PD2028B
		IC554, 555 OP-AMP IC	NJM2114D
Δ		IC620, 621 IC PROTECTOR	ICP-N15
		IC661, 662 OP-AMP IC	NJM2114D
Δ		IC671 REGULATOR IC	NJM7818FA
Δ		IC672 REGULATOR IC	NJM7918FA
		IC800 OP-AMP IC	NJM2114D
		IC850 OP-AMP IC	NJM2114D
		Q521 TRANSISTOR	DTC124ES
		Q522, 523 TRANSISTOR	DTA124ES

Mark	No.	Description	Part No.
	C519	ELECT. CAPACITOR	CENA102M16
	C520	ELECT. CAPACITOR	CEAS331M50
	C521	AUDIO FILM CAPACITOR	CFTXA473J50
	C522	AUDIO FILM CAPACITOR	CFTXA682J50
	C523	CERAMIC CAPACITOR(0.01)	PCL1029
	C524	ELECT. CAPACITOR	CENA102M16
	C526	AUDIO FILM CAPACITOR	CFTXA104J50
	C527	MYLAR FILM CAPACITOR	CQMA473J50
	C528	ELECT. CAPACITOR	CENA102M16
	C529	MYLAR FILM CAPACITOR	CQMA473J50
	C530, 531	AUDIO FILM CAPACITOR	CFTXA682J50
	C532	ELECT. CAPACITOR	CENA102M16
	C534	AUDIO FILM CAPACITOR	CFTXA104J50
	C535	ELECT. CAPACITOR	CENA102M16
	C538, 539	CERAMIC CAPACITOR	CCCCH120J50
	C542, 543	MICA CAPACITOR	CMA181J500
	C544, 545	MICA CAPACITOR	CMA330J500
	C546, 547	AUDIO FILM CAPACITOR	CFTXA473J50
	C550, 551	MICA CAPACITOR	CMA181J500
	C552, 553	MICA CAPACITOR	CMA330J500
	C554, 555	AUDIO FILM CAPACITOR	CFTXA104J50
	C556, 557	ELECT. CAPACITOR	CENA102M16
	C558, 559	AUDIO FILM CAPACITOR	CFTXA104J50
	C560-563	MICA CAPACITOR	CMA470J500
	C564, 565		CFTXA681J50
	C566, 567		CFTXA562J50
	C568-571	ELECT. CAPACITOR(22 μ)	VCH1070
	C572, 573	ELECT. CAPACITOR(47 μ)	PCH1094
	C576, 577	ELECT. CAPACITOR	CENA102M16
	C578, 579	AUDIO FILM CAPACITOR	CFTXA103J50
	C580	CERAMIC CAPACITOR	CCCCH120J50
	C581	AUDIO FILM CAPACITOR	CFTXA104J50
	C582, 583	AUDIO FILM CAPACITOR	CFTXA683J50
	C586	AUDIO FILM CAPACITOR	CFTXA473J50
	C587, 588	ELECT. CAPACITOR(22/35)	PCH1099
	C589	ELECT. CAPACITOR	CENA102M16
	C590	AUDIO FILM CAPACITOR	CFTXA104J50
	C591	AUDIO FILM CAPACITOR	CFTXA682J50
	C593, 594	ELECT. CAPACITOR	CENA102M16
	C595	AUDIO FILM CAPACITOR	CFTXA104J50
	C596	AUDIO FILM CAPACITOR	CFTXA103J50
	C597	ELECT. CAPACITOR	CENA102M16
	C598	AUDIO FILM CAPACITOR	CFTXA103J50
	C600	ELECT. CAPACITOR	CENA102M50
	C610-618	AUDIO FILM CAPACITOR	CFTXA103J50
	C655, 656	ELECT. CAPACITOR	CENA222M35
	C657, 658	AUDIO FILM CAPACITOR	CFTXA563J50
	C661, 662	ELECT. CAPACITOR	CENA100M50
	C663, 664	AUDIO FILM CAPACITOR	CFTXA563J50
	C665, 666	ELECT. CAPACITOR	CENA471M50
	C671, 672	ELECT. CAPACITOR	CENA010M50
	C673, 674	ELECT. CAPACITOR	CENA100M50
	C800, 801	ELECT. CAPACITOR(47 μ)	PCH1094
	C802, 803	ELECT. CAPACITOR	CENA471M35
	C850, 851	ELECT. CAPACITOR(47 μ)	PCH1094
	C852, 853	ELECT. CAPACITOR	CENA471M35

Mark	No.	Description	Part No.
RESISTORS			
	R500	CARBONFILM RESISTOR	RD1/6PM105J
	R501	CARBONFILM RESISTOR	RD1/6PM□□□J
	R502	CARBONFILM RESISTOR	RD1/4PM□□□J
	R503, 504	CARBONFILM RESISTOR	RD1/6PM□□□J
	R505	METAL OXIDE RESISTOR	RS1LMF□□□J
	R507-513	CARBONFILM RESISTOR	RD1/6PM□□□J
	R514	CARBONFILM RESISTOR	RD1/4PM□□□J
	R520, 521	CARBONFILM RESISTOR	RD1/6PM□□□J
	R522	METAL OXIDE RESISTOR	RS1LMF□□□J
	R524	METAL OXIDE RESISTOR	RS1LMF□□□J
	R526, 527	CARBONFILM RESISTOR	RD1/6PM□□□J
	R528-530	CARBONFILM RESISTOR	RDR1/4PM□□□J
	R540-567	CARBONFILM RESISTOR	RDR1/4PM□□□J
	R568-571	CARBONFILM RESISTOR	RDM1/2P□□□J
	R572	CARBONFILM RESISTOR	RD1/6PM□□□J
	R573, 574	CARBONFILM RESISTOR	RDM1/2P□□□J
	R575	CARBONFILM RESISTOR	RD1/6PM□□□J
	R576-585	CARBONFILM RESISTOR	RDM1/2P□□□J
	R586, 587	CARBONFILM RESISTOR	RD1/6PM□□□J
	R588-593		RDM1/2P□□□J
	R594, 595	CARBONFILM RESISTOR	RDR1/4PM□□□J
	R621, 622	CARBONFILM RESISTOR	RDR1/2PM□□□J
	R661-666	CARBONFILM RESISTOR	RDR1/4PM□□□J
	R671, 672	CARBONFILM RESISTOR	RDR1/4PM□□□J
	R801-813	CARBONFILM RESISTOR	RDM1/2P□□□J
	R851-863	CARBONFILM RESISTOR	RDM1/2P□□□J
OTHERS			
	X512	XTAL RES (OSC)	PSS1011
OPERATE B BOARD ASSEMBLY			
SEMICONDUCTORS			
	D403	LED	SLH-34YC3H3
	D404, 405	LED	SLH-34VC3H3
SWITCHES			
	S407, 408	SWITCH	PSG-065
CAPACITORS			
	C410, 411	AXIAL CERAMIC C.	CCPUCH100J50
RESISTORS			
	R414	CARBONFILM RESISTOR	RD1/6PM□□□J
OPERATE A BOARD ASSEMBLY			
SEMICONDUCTORS			
	IC401	FL MCU	PDG036
	Q401	TRANSISTOR	2SC1740S
	Q402-406	TRANSISTOR	DTA124ES
	D401	LED	AA0045
	D402	LED	BR0045
SWITCHES			
	S401-406	SWITCH	PSG-065
COILS/TRANSFORMERS			
	L401, 402	AXIAL INDUCTOR	LAU010K
CAPACITORS			
	C401	ELECT. CAPACITOR	CEJA330M16

Mark	No.	Description	Part No.	Mark	No.	Description	Part No.
	C402	AUDIO FILM CAPACITOR	CFTXA103J50		Q25		DTA124ES(PD-95)
	C403	CERAMIC CAPACITOR	CGCYF473Z25		Q181-183	TRANSISTOR	2SC1740SLN
	C404-409	AXIAL CERAMIC C.	CCPUCH100J50		Q304	TRANSISTOR	2SA1399
	C412	CERAMIC CAPACITOR	CKCYF103Z50	△	D5, 6	DIODE	10E2
RESISTORS				△	D7-10		31DF2-FC5
	R401, 402	CARBONFILM RESISTOR	RD1/6PM□□□J	△	D11	ZENER DIODE	HZ27-1/2L
	R404-407	CARBONFILM RESISTOR	RD1/6PM□□□J	△	D12	ZENER DIODE	HZ20-1L
	R408	RESISTOR ARRAY (47K)	RA10S□□□J	△	D17-20		31DF2-FC5
	R409-412	CARBONFILM RESISTOR	RD1/6PM□□□J	△	D21-26	DIODE	11ES2
	R415-417	CARBONFILM RESISTOR	RD1/6PM□□□J		D146		1SS254(PD-95)
	R418	CARBONFILM RESISTOR	RD1/6PM471J(PD-S95)		D147	DIODE	1SS254
	R419	CARBONFILM RESISTOR	RD1/6PM331J(PD-95)		D148	DIODE	1SS254(PD-S95)
	R420	CARBONFILM RESISTOR	RD1/6PM391J(PD-S95)		D181-183	DIODE	1SS254
			RD1/6PM331J(PD-95)		D701-704	DIODE	1SS292(PD-S95)
			RD1/6PM471J(PD-S95)		D720-723	DIODE	1SS292
			RD1/6PM331J(PD-95)	COILS/TRANSFORMERS			
OTHERS					L3	RADIAL INDUCTOR	LFA010K
	REMOTE SENSOR		SBX1610-51		L4	COIL	PTL1003
	CN401	CONNECTOR	HLEM25R-1(PD-S95)		L5-9		PTH1006
	V401	FL TUBE	HLEM23R-1(PD-95)		L16-40		PTH1006
	X401	CERAMIC RESONATOR	PEL1025		L41	COIL	PTL1003(PD-S95)
			VSS1014		L43		PTH1006
MAIN BOARD ASSEMBLY					L51	AXIAL INDUCTOR	LAU010K
SEMICONDUCTORS				CAPACITORS			
	IC1	PRE AMP IC	CXA1081S		C1	AUDIO FILM CAPACITOR	CFTXA472J50
	IC2	SERVO CONTROL IC	CXA1082BS		C2-4	CERAMIC CAPACITOR	CCCCH300J50
	IC3	EFM DEMODULATION IC	CXD1167Q		C5	ELECT. CAPACITOR	CENA221M25
	IC4	MICROCOMPUTER, IC	PD3179B		C7	ELECT. CAPACITOR	CENA221M25
	IC9	IC	MC74HCU04N		C9	CERAMIC CAPACITOR	CGCYF473Z25
	IC10	SYSTEM RESET IC	MS1957AL		C10	ELECT. CAPACITOR	CEAS101M10
△	IC11	REGULATOR IC	NJM7805FA		C11	AUDIO FILM CAPACITOR	CFTXA333J50
	IC12	OP-AMP IC	NJM2114D		C12	ELECT. CAPACITOR	CENA101M25
△	IC13	REGULATOR IC	AN7810F		C13	AUDIO FILM CAPACITOR	CFTXA332J50
△	IC14	REGULATOR IC	AN7910F		C14	AUDIO FILM CAPACITOR	CFTXA103J50
	IC15	REGULATOR IC	NJM7812FA		C15	ELECT. CAPACITOR	CENA101M25
	IC16	REGULATOR IC	NJM7912FA		C16	ELECT. CAPACITOR	CEASR47M50
△	IC17-19	POWER OP-AMP	TA8410K		C17	AUDIO FILM CAPACITOR	CFTXA103J50
△	IC20	S. REGULATOR	NJM431L		C18	ELECT. CAPACITOR	CENA471M16
△	IC21	REGULATOR IC	AN7810F		C21	AUDIO FILM CAPACITOR	CFTXA333J50
	IC22	REGULATOR IC	AN7910F		C22	ELECT. CAPACITOR	CEASR47M50
△	IC23	S. REGULATOR	NJM431L		C23	ELECT. CAPACITOR	CENA101M25
△	IC30-34	IC PROTECTOR	ICP-N10		C24, 25	ELECT. CAPACITOR	CEAS101M25
	IC101	IC	MC74HCU04N(PD-S95)		C26	ELECT. CAPACITOR	CENA101M25
	IC181, 182	IC	NJM072DE		C27	AUDIO FILM CAPACITOR	CFTXA153J50
	IC721	REGULATOR IC	NJM78L05A		C29		CFTXA152J50
	Q4	TRANSISTOR	DTC124ES		C31, 32	AUDIO FILM CAPACITOR	CFTXA104J50
	Q6	TRANSISTOR	2SC1740SLN		C33		CFTXA102J50
	Q7	TRANSISTOR	2SA933SLN		C34	ELECT. CAPACITOR	CEAS470M10
	Q8, 9	TRANSISTOR	2SC1740SLN		C35	AUDIO FILM CAPACITOR	CFTXA104J50
	Q10	TRANSISTOR	2SA1399		C36	ELECT. CAPACITOR	CENA101M25
△	Q11	TRANSISTOR	2SC3179		C37	AUDIO FILM CAPACITOR	CFTXA473J50
△	Q12, 13	TRANSISTOR	2SA1262		C38	ELECT. CAPACITOR	CENA102M16
△	Q14	TRANSISTOR	2SC3179		C41	ELECT. CAPACITOR	CENA102M16
	Q15	TRANSISTOR	2SB715		C42	AUDIO FILM CAPACITOR	CFTXA124J50
	Q16	TRANSISTOR	2SD755		C43	ELECT. CAPACITOR	CEAS101M10
	Q20, 21		DTA124ES(PD-95)		C44	AUDIO FILM CAPACITOR	CFTXA223J50
	Q22	TRANSISTOR	DTC124ES		C45	AUDIO FILM CAPACITOR	CFTXA104J50
	Q23	TRANSISTOR	DTC124ES(PD-S95)				

Mark	No.	Description	Part No.	Mark	No.	Description	Part No.
C46		AUDIO FILM CAPACITOR	CFTXA103J50	C152, 153		ELECT. CAPACITOR	CEAS330M35
C47		ELECT. CAPACITOR	CENA101M25	C156, 157		CERAMIC CAPACITOR	CKCYF103Z50
C48		ELECT. CAPACITOR	CEAS3R3M50	C161		CERAMIC CAPACITOR	CKCYF103Z50
C49		AUDIO FILM CAPACITOR	CFTXA472J50	C164		CERAMIC CAPACITOR	CKCYF103Z50
C50		ELECT. CAPACITOR	CEAS330M35	C166, 167		CERAMIC CAPACITOR	CKCYF103Z50
C51			CFTXA102J50	C168-175		CERAMIC CAPACITOR (0.01)	PCL1029
C52		CERAMIC CAPACITOR	CGCYF473Z25	C178, 179		CERAMIC CAPACITOR (0.01)	PCL1029
C53		MYLAR FILM CAPACITOR	CQMA471J50	C181		ELECT. CAPACITOR	CEAS101M25
C54		AUDIO FILM CAPACITOR	CFTXA224J50	C182		AUDIO FILM CAPACITOR	CFTXA103J50
C55		ELECT. CAPACITOR	CENA102M35	C183		AUDIO FILM CAPACITOR	CFTXA332J50
C56		AUDIO FILM CAPACITOR	CFTXA103J50	C184		CERAMIC CAPACITOR	CCCSL101J50
C59, 60		AUDIO FILM CAPACITOR	CFTXA103J50	C185, 186		ELECT. CAPACITOR	CEAS330M35
C61, 62		AUDIO FILM CAPACITOR	CFTXA104J50	C187		AUDIO FILM CAPACITOR	CFTXA332J50
C67			CFTXA681J50	C188		CERAMIC CAPACITOR	CCCSL150J50
C68		AUDIO FILM CAPACITOR	CFTXA104J50	C191-193		AUDIO FILM CAPACITOR	CFTXA103J50
C69		ELECT. CAPACITOR	CEASR33M50	C195-197		AUDIO FILM CAPACITOR	CFTXA103J50
C70-73		AUDIO FILM CAPACITOR	CFTXA103J50	C200		AUDIO FILM CAPACITOR	CFTXA103J50
C80		ELECT. CAPACITOR	CEAS470M50	C203, 204		CERAMIC CAPACITOR (0.01)	PCL1029
C81		CERAMIC CAPACITOR	CKCYF103Z50	C206-209		CERAMIC CAPACITOR (0.01)	PCL1029
C82		CERAMIC CAPACITOR	CCCSL680J50	C211, 212		CERAMIC CAPACITOR (0.01)	PCL1029
C83		CERAMIC CAPACITOR	CGCYF473Z25	C701		CERAMIC CAPACITOR	CKCYF103Z50 (PD-S95)
C84, 85		ELECT. CAPACITOR	CEAS101M25	C702		CERAMIC CAPACITOR	CCCSL101J50 (PD-S95)
C86		CERAMIC CAPACITOR	CCCCH300J50	C720		CERAMIC CAPACITOR	CGCYF473Z25
C87		ELECT. CAPACITOR	CEAS330M35	C721 (0.47F/5.5)			PCH1062
C88		ELECT. CAPACITOR	CEAS101M50	C722		CERAMIC CAPACITOR	CKCYF103Z50
C90, 91		ELECTR. CAPACITOR (3300)	PCH1104	C201, 202			CFTXA103J50
C92, 93		ELECT. CAPACITOR	CENA102M35	RESISTORS			
C96, 97		ELECT. CAPACITOR	CENA221M25	R1-8		CARBONFILM RESISTOR	RDR1/4PM□□□J
C98		ELECT. CAPACITOR	CEAS100M50	R9-13		CARBONFILM RESISTOR	RDR1/6PM□□□J
C99		ELECT. CAPACITOR	CEAS101M50	R14		CARBONFILM RESISTOR	RDR1/2PM□□□J
C100, 101		ELECT. CAPACITOR (3300)	PCH1104	R16-22		CARBONFILM RESISTOR	RD1/6PM□□□J
C102, 103		ELECT. CAPACITOR	CENA222M16	R24-29		CARBONFILM RESISTOR	RD1/6PM□□□J
C104, 105		AUDIO FILM CAPACITOR	CFTXA103J50	R30		METALFILM RESISTOR	RN1/6PQ□□□□F
C106, 107		AUDIO FILM CAPACITOR	CFTXA104J50	R31, 32		CARBONFILM RESISTOR	RDR1/4PM□□□J
C108, 109		CERAMIC CAPACITOR	CCCCH101J50	R34-41		CARBONFILM RESISTOR	RD1/6PM□□□J
C111		ELECT. CAPACITOR	CEAS101M10	R43-51		CARBONFILM RESISTOR	RD1/6PM□□□J
C112		AUDIO FILM CAPACITOR	CFTXA473J50	R53		CARBONFILM RESISTOR	RDR1/4PM□□□J
C122			CCCSL331J50 (PD-S95)	R54-57		CARBONFILM RESISTOR	RD1/6PM□□□J
C113		AUDIO FILM CAPACITOR	CFTXA103J50	R58, 59		CARBONFILM RESISTOR	RDR1/4PM□□□J
C114		ELECT. CAPACITOR	CENA470M25	R60		CARBONFILM RESISTOR	RD1/6PM□□□J
C115		CERAMIC CAPACITOR	CKCYF103Z50	R61		CARBONFILM RESISTOR	RDR1/4PM□□□J
C117			CCCSL471J50 (PD-95)	R62-65		CARBONFILM RESISTOR	RD1/6PM□□□J
C117			CCCSL331J50 (PD-S95)	R66-69		CARBONFILM RESISTOR	RDR1/4PM□□□J
C118		AUDIO FILM CAPACITOR	CFTXA473J50	R74-76		CARBONFILM RESISTOR	RD1/6PM□□□J
C119		CERAMIC CAPACITOR	CKCYF103Z50	R81-83		CARBONFILM RESISTOR	RD1/6PM□□□J
C120		ELECT. CAPACITOR	CENA470M25 (PD-S95)	R84		CARBONFILM RESISTOR	RDR1/2PM□□□J
C121		AUDIO FILM CAPACITOR	CFTXA103J50 (PD-S95)	R86		CARBONFILM RESISTOR	RDR1/2PM□□□J
C125		CERAMIC CAPACITOR	CKCYF103Z50 (PD-S95)	R88		CARBONFILM RESISTOR	RD1/6PM□□□J
C127		CERAMIC CAPACITOR	CKCYF103Z50	R90		CARBONFILM RESISTOR	RDR1/4PM□□□J
C128		CERAMIC CAPACITOR	CKCYF103Z50 (PD-S95)	R100, 101		CARBONFILM RESISTOR	RD1/6PM□□□J
C130, 131		CERAMIC CAPACITOR	CKCYF103Z50	R104		CARBONFILM RESISTOR	RDM1/2P□□□J
C134		AUDIO FILM CAPACITOR	CFTXA103J50	R106		CARBONFILM RESISTOR	RD1/6PM□□□J
C135		CERAMIC CAPACITOR	CCCCH120J50 (PD-S95)	R107		CARBONFILM RESISTOR	RDM1/2P750J (D-S95)
C136		CERAMIC CAPACITOR	CCCCH330J50 (PD-S95)	R108-111		CARBONFILM RESISTOR	RDR1/4PM□□□J
C141		CERAMIC CAPACITOR	CCDSL101J50	R112, 113		CARBONFILM RESISTOR	RD1/6PM□□□J
C147, 148		ELECT. CAPACITOR	CENA331M25	R114		CARBONFILM RESISTOR	RDR1/4PM□□□J
C151		CERAMIC CAPACITOR	CKCYF103Z50	R115, 116		CARBONFILM RESISTOR	RD1/6PM□□□J

Mark	No.	Description	Part No.
	R117		RDM1/2P102J(PD-95)
	R119-121	CARBONFILM RESISTOR	RDR1/4PM□□□J
	R123	CARBONFILM RESISTOR	RD1/6PM□□□J
	R124-129	CARBONFILM RESISTOR	RDR1/4PM□□□J
	R131, 132	CARBONFILM RESISTOR	RDR1/4PM□□□J
	R133-135	CARBONFILM RESISTOR	RD1/6PM□□□J
	R136-139	CARBONFILM RESISTOR	RDR1/4PM□□□J
	R141, 142	CARBONFILM RESISTOR	RDR1/4PM□□□J
	R143, 144	CARBONFILM RESISTOR	RD1/6PM□□□J
	R146		RDR1/4PM103J(PD-95)
	R147		RD1/60M331J(PD-95)
	R148		RDM1/2P102J(PD-95)
	R149		RD1/6PM331J(PD-95)
	R150	CARBONFILM RESISTOR	RDR1/4PM□□□J
	R151-157	CARBONFILM RESISTOR	RD1/6PM□□□J
	R158, 159		RDM1/2P102J(PD-S95)
	R160	CARBONFILM RESISTOR	RDR1/4PM103J (PD-S95)
	R161-167	CARBONFILM RESISTOR	RD1/6PM□□□J
	R168		RDM1/2P□□□J
	R178	CARBONFILM RESISTOR	RDM1/2P□□□J
	R181-193	CARBONFILM RESISTOR	RD1/6PM□□□J
	R194-196	CARBONFILM RESISTOR	RDR1/4PM□□□J
	R303, 304		PCX1024(PD-95)
	R701	CARBONFILM RESISTOR	RD1/6PM244J(PD-S95)
	R702	CARBONFILM RESISTOR	RD1/6PM102J(PD-S95)
	R721	CARBONFILM RESISTOR	RD1/6PM□□□J
	VR2	SEMI-FIXED RESISTOR	VRTB6VS103
	VR3-7	VR	VRTB6VS223
	VR8	VR	VRTS6VS102
	VR9	VR	VRTB6VS473
	VR10	VR	VRTS6VS472
OTHERS			
	CN1		52045-1710
	CN2		5597-05CPB
	CN6	CONNECTOR	HLEM25S-1(PD-S95) HLEM23R-1(PD-95)
	DL1, 2	FILTER	PTF1009
	JA2	JACK	PKB1004
	JA3		TOTX174
	JA701, 702	JACK	RKN1004(PD-S95)
	X1	CERAMIC RESONATOR	RSS1033
	X2	XTAL RES (OSC)	PSS1019(PD-S95)

TRANSFORMER PRIMARLY ASSEMBLY

SWITCHES

△	S301	POWER SWITCH	PSA1002
---	------	--------------	---------

COILS/TRANSFORMERS

△	L301	FILTER	PTL1002
---	------	--------	---------

CAPACITORS

	C301		VCG-048(PD-95)
△	C302-304	CAPACITOR (CERAMIC)	VCG-048

OTHERS

△		TERMINAL	RKC-061
---	--	----------	---------

Mark	No.	Description	Part No.
BALLANCE R BOARD ASSEMBLY (PD-95 only)			
CAPACITORS			
	C892		CFTXA102J50
	C894		CFTXA102J50

BALLANCE L BOARD ASSEMBLY (PD-95 only)			
CAPACITORS			
	C891		CFTXA102J50
	C893		CFTXA102J50

LINE L BOARD ASSEMBLY (PD-95 only)

COILS/TRANSFORMERS			
	L540	FILTER	PTH1011
	F584	FILTER	VTH1001

LINE R BOARD ASSEMBLY (PD-95 only)

COILS/TRANSFORMERS			
	L541	FILTER	PTH1011
	F585	FILTER	VTH1001

BNC BOARD ASSEMBLY (PD-S95 only)

CAPACITORS			
	C751	CERAMIC CAPACITOR	CKCYF103Z50

7. ADJUSTMENTS

Perform the following adjustments in the indicated order.

● Adjustments

1. Tracking error offset, focus error offset and RF offset adjustment.
2. Tracking return offset adjustment.
3. Focus lock and spindle lock check.
4. Grating adjustment.
5. Tracking balance adjustment.
6. Tangential adjustment
7. Radial adjustment
8. RF level check
9. Focus gain adjustment
10. Tracking gain adjustment
11. VCO free-running frequency adjustment
12. Method of focus error check

● Measuring Devices

1. Dual-trace oscilloscope
2. Light power meter
3. YEDS-7 test disc
4. Focus and tracking adjustment filter
5. Loop gain adjustment band-pass filter
6. Signal generator
7. Grating driver
8. General-use tools
9. Commercial available disc (8 cm and 12 cm)
10. Hex. wrenchdriver (GGK 1002, 1.5 mm)

● About the test mode

How to activate and release the test mode

- ① To activate the test mode, turn ON the power switch with the test mode jumper short-circuited.
- ② The test mode is released by turning the power switch OFF.

The functions of the keys in the test mode are outlined in Table 1.

● Adjustment Volume Name

- VR2: RF offset (RF. OF)
- VR3: Focus gain (FO. GA)
- VR4: Tracking gain (TR. GA)
- VR5: Tracking balance (TR. BL)
- VR6: Focus error offset (FO. OF)
- VR7: Tracking error offset (TE. OF)
- VR8: VCO frequency counter (VCOA)
- VR9: Tracking return offset (TR. OF)
- VR10: RF level (RF.LEV)

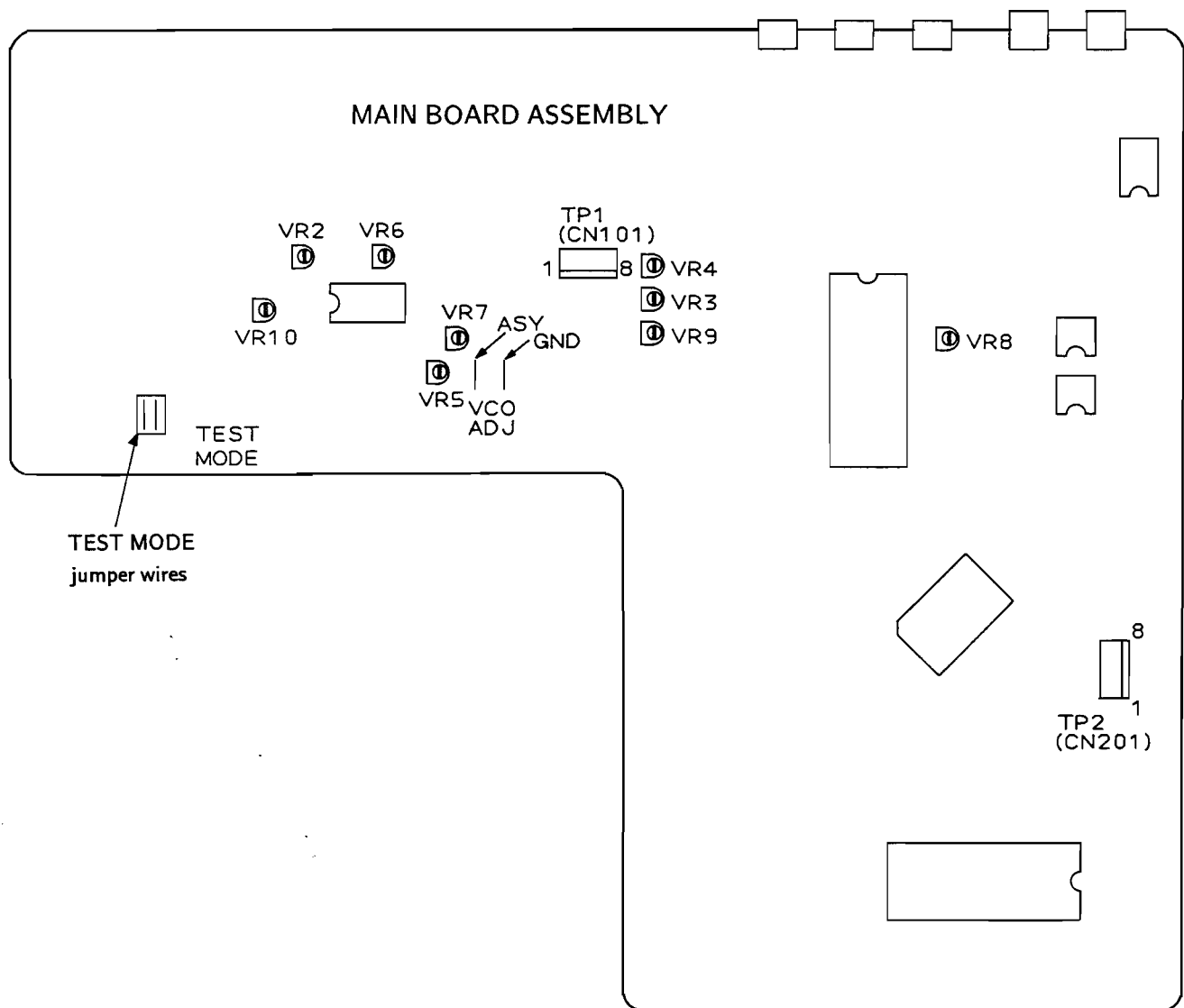
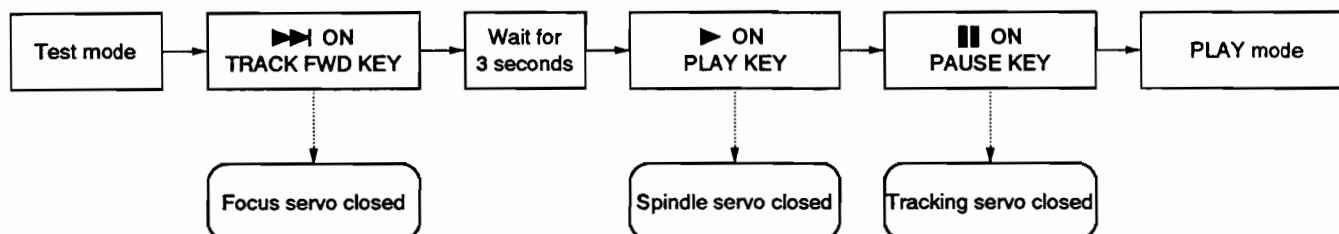


Fig.1 Adjusting point

In the test mode, closing and opening of servos is performed independently. Therefore, to set the play mode the servos have to be closed in (serial) sequence. Remember that in the test mode the play mode can't be set simply by pressing PAUSE (||) key.

For example, to set the play mode from the stop mode, press the following keys in the indicated order.



* In the test mode, servos keep a serial sequence.

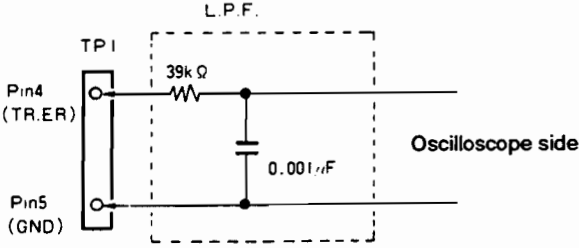
● Function of Each Key in the Test Mode

Symbol	Key name	Function during test mode	Description
▶▶	TRACK FWD	Focus servo close	Lights the laser diode and sets the focus actuator UP/DOWN to close the focus servo.
▶	PLAY	Spindle servo close	After kicking the spindle motor, it closes the servo in the CLV-H mode.
	PAUSE	Tracking servo close/open	Performs a toggle operation. When pressed, the tracking servo is closed and the unit enters the play mode (the focus servo and spindle servo should be already closed). At this time the PAUSE indicator lights. If pressed again, the tracking servo opens.
	OUTPUT	Carriage reverse (inward)	Moves the carriage inwards at high (approx. 1 cm/s) speed. Since there is no safety device to stop the carriage, be sure to stop it manually in time.
	DISPLAY	Carriage forward (outward)	Moves the carriage outwards at high (approx. 1 cm/s) speed. Since there is no safety device to stop the carriage, be sure to stop it manually in time.
■	STOP	Stop	Stops all servos and returns the unit to the initial condition.
▲	OPEN/CLOSE	(Disc tray) open/close	Opens and closes the disc tray. However, the pickup does not return to the rest position when the tray is opened. It does not move either when the tray is closed.

Table 1.

Step No.	Oscilloscope setting		Test points	Adjusting points	Check items/ adjustment specifications	Adjustment procedure
	V	H				
1	Tracking error offset, focus error offset and RF offset adjustment					
		TP1	TP1 Pin 4 (TR. ER)	VR7 (TE. OF)	0V ± 50 mV	<ul style="list-style-type: none"> ● Set the test mode. (*) ● Adjust VR7 (TE. OF: tracking error offset) so that the voltage at Pin 4 (TE: tracking error) of TP1 becomes 0V ± 50 mV. ● Adjust VR6 (FO. OF: focus error offset) so that the voltage at Pin 6 (FO. ER: focus error) of TP1 becomes 0V ± 50 mV. ● Adjust VR2 (RF. OF: RF offset) so that RF output voltage at Pin 1 of TP 1 becomes 100 mV ± 50 mV.
		TP1	TP1 Pin 6 (FO. ER)	VR6 (FO.OF)	0V ± 50 mV	
		TP1	TP 1 Pin 1 (RF)	VR2 (RF. OF)	100 mV ± 50 mV	
2	Tracking return offset adjustment					
		TP1	TP1 Pin 2 (TR. RT)	VR9 (TR. OF)	0V ± 10 mV	<ul style="list-style-type: none"> ● Set the test mode. (*) ● Adjust VR9 (TR. OF: tracking return offset) so that the voltage at Pin 2 TR. RT (tracking return) of TP1 becomes 0V ± 10 mV.
3	Focus lock and spindle lock check					
	V 0.5V/div	H 100 msec /div	TP 1 Pin 1 (RF output)		RF output Clockwise rotation	<ul style="list-style-type: none"> ● Load the disc. ● Set the test mode. (*) ● Move the pickup close to the center of the disc using DISPLAY Key. Be sure to perform this operation. ● Observe Pin 1 RF (RF output) of TP 1 with an oscilloscope and confirm that RF signal is output after pressing TRACK FWD key (▶▶). ● Press PLAY key (▶) and confirm that the disc rotates clockwise at approx. normal speed (about 300 rpm around the center of the disc), without running wildly or in reverse direction.

* See Page 36.

Step No.	Oscilloscope setting		Test points	Adjusting points	Check items/ adjustment specifications	Adjustment procedure
	V	H				
4-1	Grating adjustment (1) (with an 8 cm disc)					
	1V/div	5 ms/div	TP1 Pin 4 (TR. ER)	Grating	Null point	<ul style="list-style-type: none"> ● This adjustment can be performed with an 8 cm disc having pits over a 75 mm in diameter. ● Load the disc. (8 cm) ● Set the test mode. (*) ● Press TRACK FWD (▶▶) and PLAY (▶) keys in that order to close the focus and spindle servos (the tracking servo is open state.) ● Press DISPLAY key and move the pickup to the outer track of the 8 cm disc. When moving the pickup, it is possible to insert a slotted screwdriver in the grating adjustment plate slot from above the unit. (Fig. 3.) ● Observe the waveform at Pin 4 TR. ER (tracking error) of TP1 with an oscilloscope and at this time, insert cut off 4 kHz low-pass filter (Fig. 2). ● Insert the tracking driver in the adjustment slot and turn it so as to find out the null point (Photo-1).
	 <p style="text-align: center;">Fig. 2.</p>					

* See Page 36.

Step No.	Oscilloscope setting		Test points	Adjusting points	Check items/ adjustment specifications	Adjustment procedure
	V	H				
4-2 Grating adjustment (2) (with an 12 cm disc playing more than 60 minutes)						
	1V/div	5 ms/div	TP1 Pin 4 (TR. ER)	Grating	Null point	<ul style="list-style-type: none"> ● Load the disc (playing more than 60 minutes). ● Set the test mode. (*) ● Press TRACK FWD (▶▶) and PLAY (▶) keys in that order to close the focus and spindle servos (the tracking servo is open state). ● Press DISPLAY key and move the pickup to the outer track of the disc. When moving the pickup, it is possible to insert a slotted screwdriver in the grating adjustment plate slot from above the unit. (Fig. 3.) ● Observe the waveform at Pin 4 TR. ER (tracking error) of TP1 with an oscilloscope and at this time, insert cut off 4 kHz low-pass filter. (Fig. 2.) ● Insert the tracking driver in the adjustment slot and turn it so as to find out the null point (Photo-1).
				Grating	Maximum amplitude	<ul style="list-style-type: none"> ● Turn the grating driver slowly clockwise from the null point and set to at the first point where the waveform amplitude (tracking error signal) is maximum. (See photo-2)

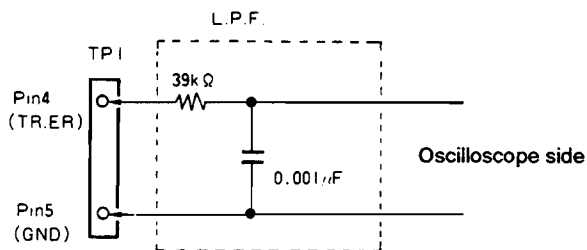


Fig. 2.

* See Page 36.

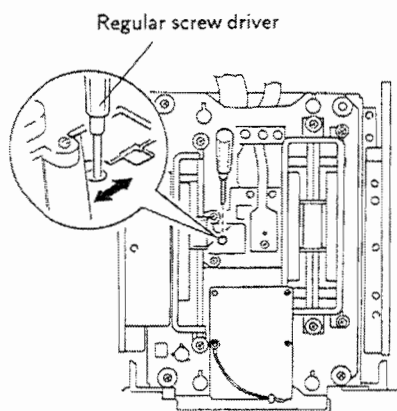


Fig. 3. Grating Adjustment

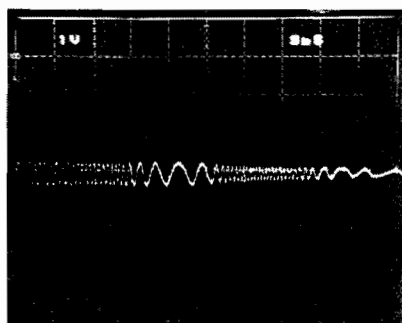


Photo-1 Null point

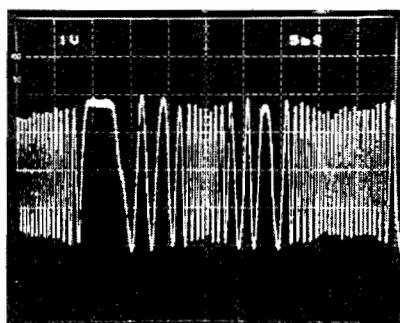


Photo-2 Maximum amplitude

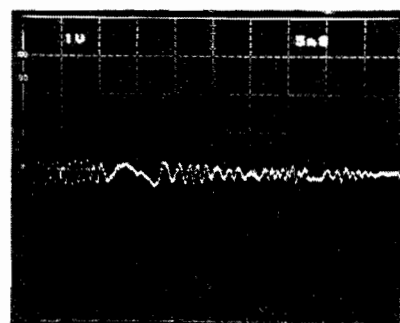
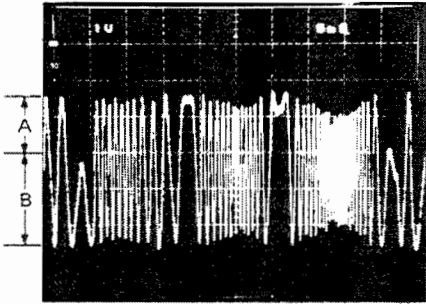
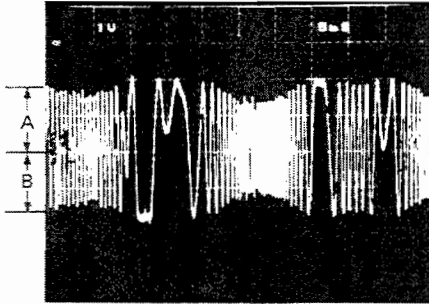


Photo-3 Out of null point

Step No.	Oscilloscope setting		Test points	Adjusting points	Check items/ adjustment specifications	Adjustment procedure
	V	H				
5	Tracking balance adjustment					
	0.5V/div	5 msec/div	TP1 Pin 4 (TR. ER)	VR5 (TR. BL)	<ul style="list-style-type: none"> ● Load the disc. ● Set the test mode. (*) ● Press DISPLAY key and move carriage close to the center track of the disc. ● Press TRACK FWD (▶▶) and PLAY (▶) keys in that order to turn the disc. ● Observe Pin 4 TR. ER (tracking error) of TP1 with an oscilloscope. And adjust VR5 TR. BL (tracking balance) so as to remove DC elements from the tracking error waveform. 	
						
						
	Photo-6					Photo-7

* See Page 36.

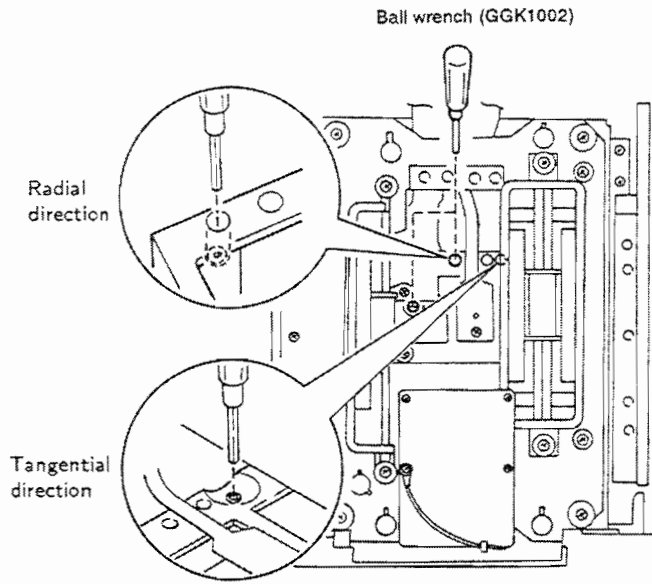


Fig. 4. Tangential Adjustment

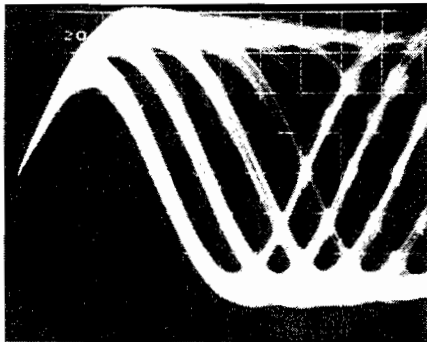


Photo-8

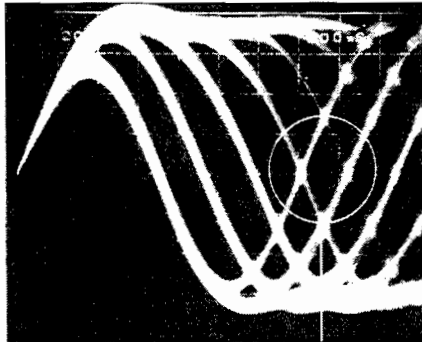


Photo-9

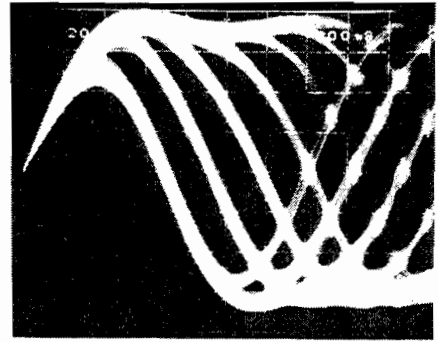
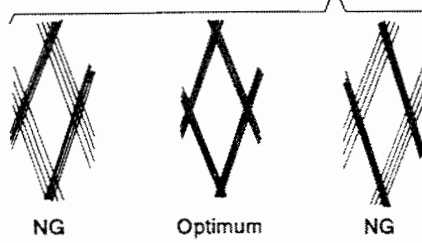


Photo-10

Part to be observed



Step No.	Oscilloscope setting		Test points	Adjusting points	Check items/ adjustment specifications	Adjustment procedure
	V	H				
6	Tangential adjustment					
			TP 1 Pin 1 (RF output)	Tangential adjustment screw	Eye pattern optimum point	<ul style="list-style-type: none"> ● Load the disc. ● Set the test mode. (*) ● Press DISPLAY key and move the pickup to the center track of the disc (set it to such a location that the tangential screw can be seen from above the servo mechanism. (See fig. 4.) ● Press TRACK FWD (▶▶), PLAY (▶) and PAUSE (⏏) keys in that order to close all servos. (Pause indicator lights.) ● Observe Pin 1 RF (RF output) of TP 1 with an oscilloscope and adjust the tangential screw so that the eye pattern becomes clear. (Fig. 4.) ● The adjustment point is located around the middle location between the point where the eye pattern becomes blurred when turning the tangential screw clockwise and the point where the eye pattern becomes blurred when turning the adjustment screw counterclockwise. <p>Observe the overall clearness of the waveform and one of the diamond shapes in the eye pattern (photo-9). Optimum adjustment is attained at the point where diamond shape lines are relatively thin.</p>

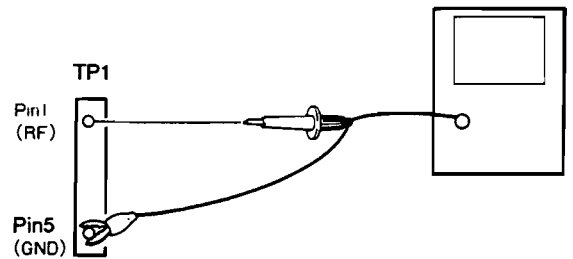
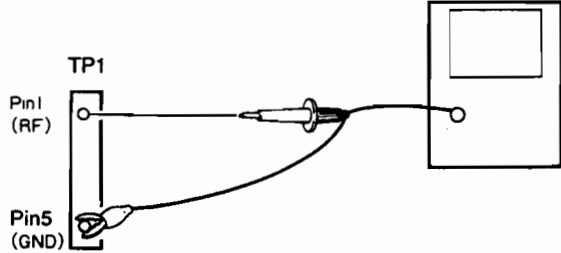


Fig. 5

* See Page 36.

Step No.	Oscilloscope setting		Test points	Adjusting points	Check items/ adjustment specifications	Adjustment procedure
	V	H				
7	Radial adjustment					
			TP 1 Pin 1 (RF output)	Radial adjustment screw	Eye pattern optimum point	<ul style="list-style-type: none"> ● Load the disc. ● Set the test mode. (*) ● Press DISPLAY key and move the pickup to the center track of the disc (set it to such a location that the tangential screw can be seen from above the servo mechanism. (See fig. 4.)) ● Press TRACK FWD (▶▶), PLAY (▶) and PAUSE (■) keys in that order to close all servos. (Pause indicator lights.) ● Observe Pin 1 RF (RF output) of TP 1 with an oscilloscope and adjust the tangential screw so that the eye pattern becomes clear. (Fig. 4.) ● The adjustment point is located around the middle location between the point where the eye pattern becomes blurred when turning the tangential screw clockwise and the point where the eye pattern becomes blurred when turning the adjustment screw counterclockwise. <p>Observe the overall clearness of the waveform and one of the diamond shapes in the eye pattern (photo-9). Optimum adjustment is attained at the point where diamond shape lines are relatively thin.</p> <ul style="list-style-type: none"> ● Perform the tangential and radial adjustments alternately two or more times.
						 <p style="text-align: center;">Fig. 5</p>

* See Page 36.

Step No.	Oscilloscope setting		Test points	Adjusting points	Check items/ adjustment specifications	Adjustment procedure
	V	H				
8	RF level check					
			TP 1 Pin 1 (RF)	Check	$1.5V \begin{smallmatrix} +0.2V \\ -0V \end{smallmatrix}$	<ul style="list-style-type: none"> ● Set the test mode. (*) ● Connect the probe of the oscilloscope to Pin 1 RF (RF output) of TP 1 . ● Play back the disc, measure the RF waveform p-p voltage and confirm that it becomes $1.5V \begin{smallmatrix} +0.2V \\ -0V \end{smallmatrix}$. ● Adjust VR 10 if the voltage does not become $1.5V \begin{smallmatrix} +0.2V \\ -0V \end{smallmatrix}$.
			TP 1 Pin 1 (RF)	VR 10	$1.5V \begin{smallmatrix} +0.2V \\ -0V \end{smallmatrix}$	

* See Page 36.

Step No.	Oscilloscope setting		Test points	Adjusting points	Check items/ adjustment specifications	Adjustment procedure
	V	H				
9	Focus gain adjustment					
	CH1 (X) , CH2 (Y) 20 mV/div, 5 mV/div (probe 10:1)		X axis: TP1 Pin 5 (FO. IN) Y axis: TP1 Pin 6 (FO. ER)	VR3 (FO. GA)	Phase difference 90°	<ul style="list-style-type: none"> ● With the power off, connect the oscilloscope and the oscillator as shown in Fig. 6. ● Set the normal playback mode. ● Turn the oscillators power on and set it to output a 1.2 kHz, 1 Vp-p signal. <p>Note: (Some oscillators output DC when turned ON. In that case, connect the oscillator after turning it on.)</p> <ul style="list-style-type: none"> ● Adjust VR3 FO. GA (focus gain) so that the resurge waveform on an oscilloscope becomes a horizontal circle (phase difference 90°).

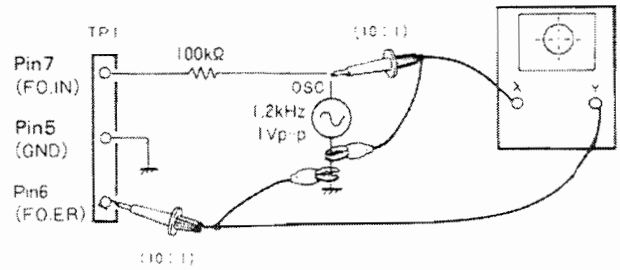
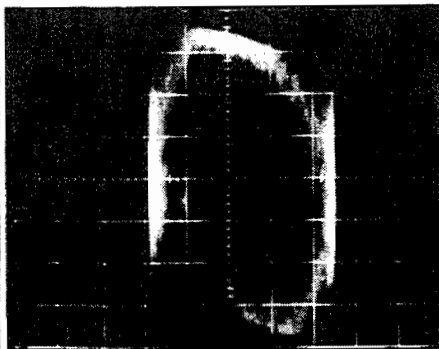
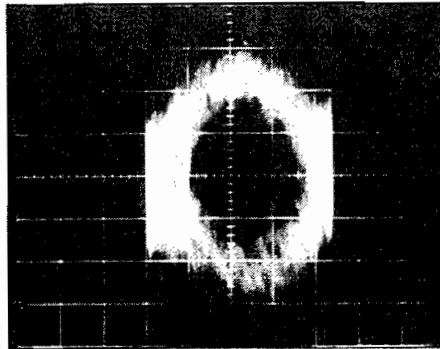


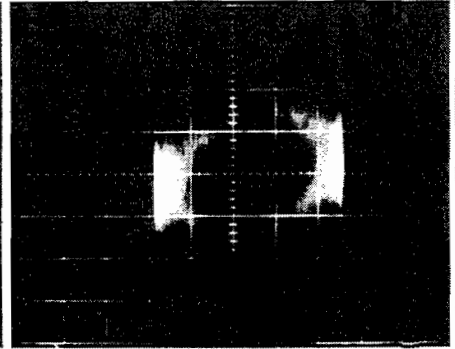
Fig. 6.



High gain
Photo-11



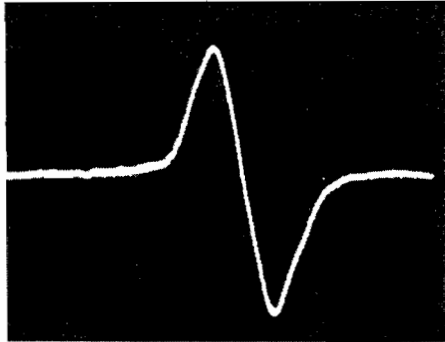
Optimum gain
Photo-12



Low gain
Photo-13

Step No.	Oscilloscope setting		Test points	Adjusting points	Check items/ adjustment specifications	Adjustment procedure
	V	H				
10	Tracking gain adjustment					
	CH1 (X), CH2 (Y) 50 mV/div, 5 mV/div (Probe 10:1)		X axis: TP1 Pin 3 (TR. IN) Y axis: TP1 Pin 2 (TR. ER)	VR4 (TR. GA)	Phase difference 90°	<ul style="list-style-type: none"> ● With the power off, connect the oscilloscope and the oscillator as shown in Fig. 7. ● Set the normal playback mode. ● Turn the oscillators power on and set it to output a 1 kHz, 2 Vp-p signal. <p>Note: (Some oscillators output DC when turned on. In that case, connect the oscillator after turning it on.)</p> <ul style="list-style-type: none"> ● Adjust VR4 TR. GA (tracking gain) so that the resurge waveform on an oscilloscope becomes a horizontal circle (phase difference 90°).
						<p style="text-align: right;">Fig. 7.</p>
						<ul style="list-style-type: none"> ● Set the test mode. (*) ● Short the ASY and GND jumpers by using a slotted screw driver or similar. ● Connect the frequency counter (10 MHz range) to Pin 2 of TP 2. ● Adjust VR8 (VCO. A) so that the frequency counter reads 4.275 MHz ± 0.025 MHz. <p>Note: Adjust with the stop mode.</p>
11	VCO free-running frequency adjustment		TP 2 Pin 2		Frequency 4.275 MHz ± 0.025 MHz	

* See Page 36.

Step No.	Oscilloscope setting		Test points	Adjusting points	Check items/ adjustment specifications	Adjustment procedure
	V	H				
12	Focus error check					
	1V/div	2 ms/div	TP1 Pin 6 (FO. ER)	Check	Waveform	<ul style="list-style-type: none"> ● Set the test mode. (*) ● Connect Pin 7 FO. IN (focus in) of TP1 to GND. ● Press TRACK FWD key and check the waveform on Pin 6 FO. ER (focus error) of TP1 with the oscilloscope.
						
<p>Focus error Photo-17</p>						

* See Page 36.

7. REGLAGES

Effectuer les réglages suivants dans l'ordre indiqué.

● Réglages

1. Réglage du décalage d'erreur d'alignement, du décalage d'erreur de mise au point et du décalage RF (fréquence radio).
2. Réglage du décalage de retour d'alignement.
3. Contrôle du verrouillage de mise au point et du verrouillage d'axe.
4. Réglage du filtre.
5. Réglage de l'équilibre d'alignement.
6. Réglage tangentiel.
7. Réglage radial.
8. Contrôle du niveau RF (fréquence radio)
9. Réglage du gain de mise au point
10. Réglage du gain d'alignement
11. Réglage de la fréquence de relaxation du VCO (oscillateur à fréquence réglée par variation de tension)
12. Méthode de contrôle d'erreur de mise au point

● Appareils de Mesure

1. Oscilloscope à double trace
2. Indicateur de puissance lumineuse
3. Disc d'essai YEDS-7
4. Filtre de réglage de mise au point et d'alignement
5. Filtre passe-bande de réglage de gain de boucle
6. Générateur de signal
7. Excitateur de filtre
8. Outils à usage général
9. Disc disponible dans le commerce (8 cm et 12 cm)
10. Clé hex. (GGK 1002, 1.5 mm)

● A propos du mode d'essai

Mise en/hors service du mode d'essai

- ① Pour activer le mode d'essai, mettre l'interrupteur d'alimentation sous tension en court-circuitant le cavalier de mode d'essai.
- ② Le mode d'essai est annulé en ramenant l'interrupteur d'alimentation sur OFF.

Les fonctions des touches en mode d'essai sont décrites au Tableau 1.

● Nom des Résistances Variables de Réglage

- VR2: Décalage RF (RF. OF)
- VR3: Gain de mise au point (FO. GA)
- VR4: Gain d'alignement (TR. GA)
- VR5: Equilibre d'alignement (TR. BL)
- VR6: Décalage d'erreur de mise au point (FO. OF)
- VR7: Décalage d'erreur d'alignement (TE. OF)
- VR8: Compteur de fréquence VCO (VCOA)
- VR9: Décalage de retour d'alignement (TR. OF)
- VR 10 : Niveau RF (RF.LEV)

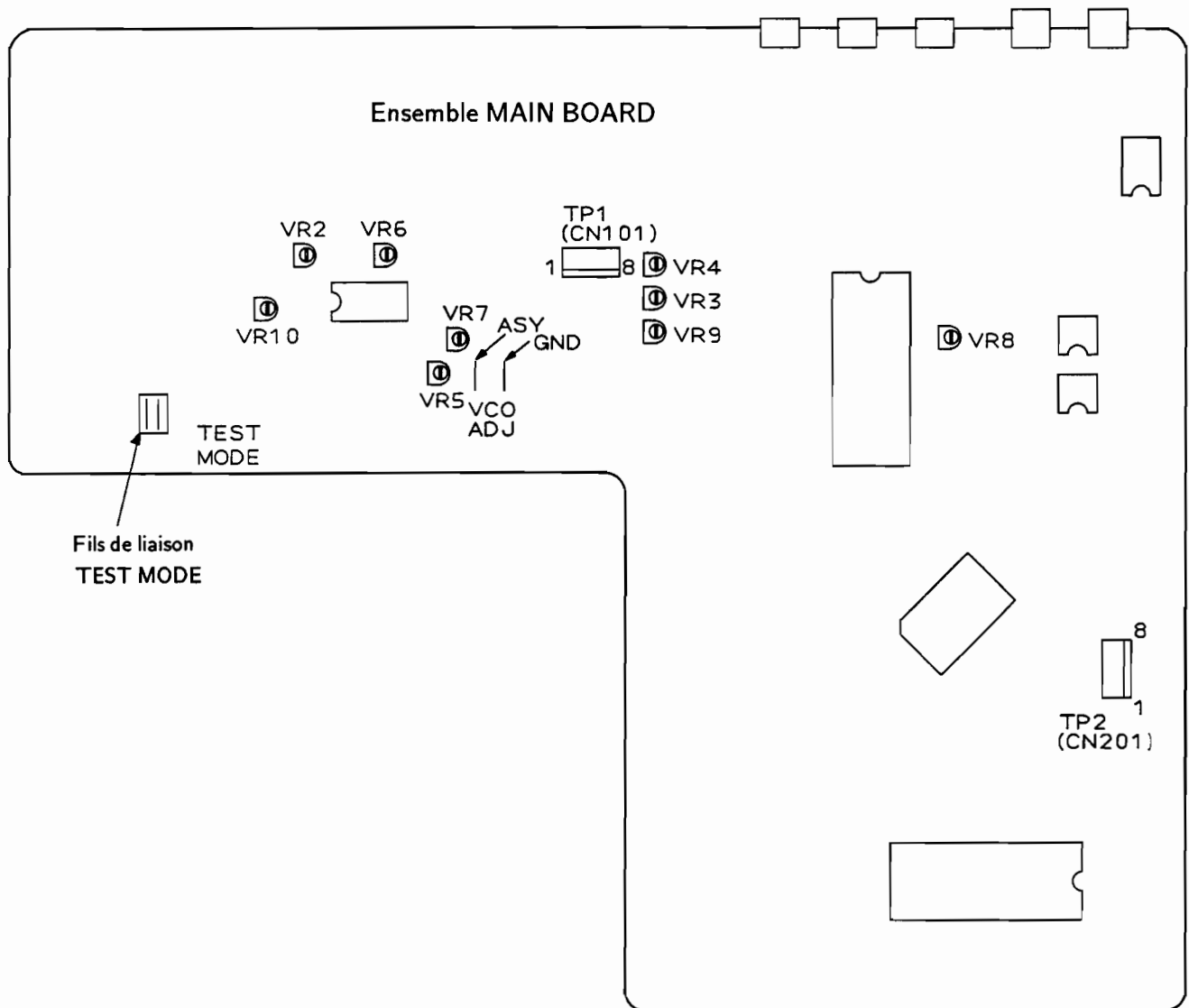
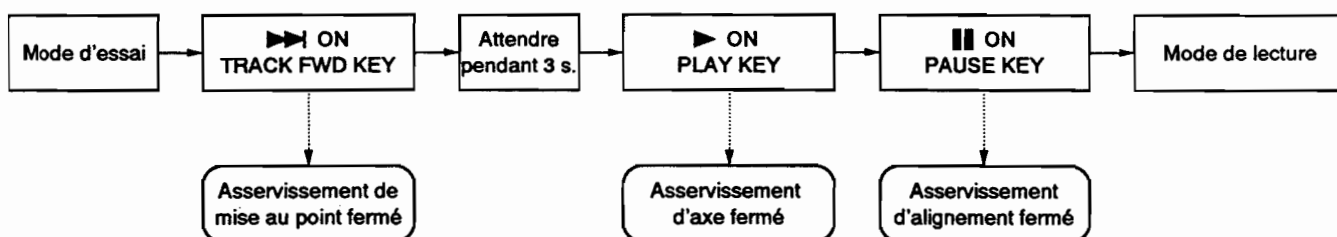


Fig.1 Points de réglage

Dans le mode d'essai, l'ouverture et la fermeture des circuits d'asservissement sont effectuées indépendamment. Par conséquent, pour régler le mode de lecture, les asservissements doivent être fermés l'un après l'autre (en série). Ne pas oublier que, dans le mode d'essai, le mode de lecture ne peut pas être réglé simplement en appuyant sur la touche PAUSE (||).

Par exemple, pour régler le mode de lecture à partir du mode d'arrêt, appuyer sur les touches suivantes dans l'ordre indiqué.



* Dans le mode d'essai, les asservissements restent en séquence sérielle.

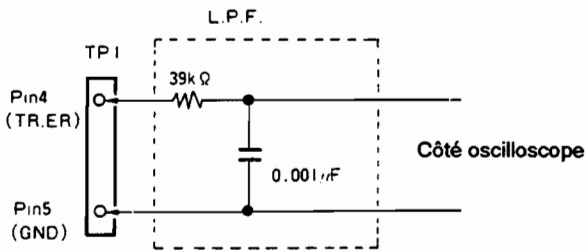
● **Fonction de Chaque Touche dans le Mode D'essai**

Symbole	Touche	Fonction en mode d'essai	Explication
▶▶	TRACK FWD	Fermeture asservissement de mise au point	Fait s'allumer la diode laser et déplace le dispositif de commande de mise au point dans le sens vertical pour fermer l'asservissement de mise au point.
▶	PLAY	Fermeture asservissement d'axe	Après le démarrage du moteur d'axe, ferme l'asservissement dans le mode CLV-H.
	PAUSE	Fermeture/ouverture asservissement d'alignement	Exécute une opération de bascule. Quand elle est enfoncée, l'asservissement d'alignement est fermé et l'appareil passe dans le mode de lecture (les asservissements de mise au point et d'axe doivent déjà être fermés). A ce moment-là le témoin de PAUSE s'allume. Si elle est de nouveau enfoncée, l'asservissement d'alignement s'ouvre.
	OUTPUT	Retour du chariot (vers l'intérieur)	Déplace le chariot vers l'intérieur à grande vitesse (approx. 1 cm/s.). Comme il n'y a pas de dispositif de sécurité pour arrêter le chariot, il faut donc l'arrêter manuellement à temps.
	DISPLAY	Avance du chariot (vers l'extérieur)	Déplace le chariot vers l'extérieur à grande vitesse (approx. 1 cm/s.). Comme il n'y a pas de dispositif de sécurité pour arrêter le chariot, il faut donc l'arrêter manuellement à temps.
■	STOP	Arrêt	Arrête tous les asservissements et ramène l'appareil à sa condition initiale.
▲	OPEN/CLOSE	Ouverture/fermeture du plateau de disc	Ouvre et ferme le plateau de disc. Le capteur ne revient cependant pas à la position d'arrêt quand le plateau est ouvert. Il ne se déplace pas non plus quand le plateau est fermé.

Tableau 1.

Etape No.	Réglage de l'oscilloscope		Points d'essai	Points de réglage	Éléments contrôlés/ spécifications de réglage	Procédure de réglage
	V	H				
1	Réglage du décalage d'erreur d'alignement, du décalage d'erreur de mise au point et du décalage RF (fréquence radio)					
		TP1	TP1 Pin 4 (TR. ER)	VR7 (TE. OF)	0V ± 50 mV	<ul style="list-style-type: none"> ● Régler le mode d'essai. (*) ● Ajuster VR7 (TE. OF: décalage d'erreur d'alignement) afin que la tension à la broche 4 (TE: erreur d'alignement) de TP1 devienne 0V ± 50 mV. ● Ajuster VR6 (FO. OF: décalage d'erreur de mise au point) afin que la tension à la broche 6 (FO. ER: erreur de mise au point) de TP1 devienne 0V ± 50 mV. ● Ajuster VR2 (RF. OF: décalage RF) afin que la tension à la broche 1 de TP1 devienne 100 mV ± 50 mV.
		TP1	TP1 Pin 6 (FO. ER)	VR6 (FO.OF)	0V ± 50 mV	
		TP1	TP 1 Pin 1 (RF)	VR2 (RF. OF)	100 mV ± 50 mV	
2	Réglage du décalage de retour d'alignement					
		TP1	TP1 Pin 2 (TR. RT)	VR9 (TR. OF)	0V ± 10 mV	<ul style="list-style-type: none"> ● Régler le mode d'essai. (*) ● Ajuster VR9 (TR. OF: décalage de retour d'alignement) afin que la tension à la broche 2 (TR. RT: retour d'alignement) de TP1 devienne 0V ± 10 mV.
3	Contrôle du verrouillage de mise au point et du verrouillage d'axe					
	V 0,5V/div	H 100 msec /div	TP 1 Pin 1 (Sortie RF)		Sortie RF Rotation dans le sens des aiguilles d'une montre	<ul style="list-style-type: none"> ● Charger le disc. ● Régler le mode d'essai. (*) ● Amener le capteur près du centre du disc en utilisant la touche DISPLAY. Toujours effectuer cette opération. ● Observer la sortie RF à la broche 1 de TP1 avec un oscilloscope et confirmer que le signal RF est sorti lorsque la touche TRACK FWD (▶▶) est enfoncée. ● Appuyer sur la touche PLAY (▶) et confirmer que le disc tourne dans le sens des aiguilles d'une montre à approximativement la vitesse normale (environ 300 tr/mn près du centre du disc), sans qu'il tourne irrégulièrement ou en sens inverse.

* Voir Page 51.

Etape No.	Réglage de l'oscilloscope		Points d'essai	Points de réglage	Éléments contrôlés/ spécifications de réglage	Procédure de réglage
	V	H				
4-1	Réglage du filtre (1) (avec un disc de 8 cm)					
	1V/div	5 ms/div	TP1 Pin 4 (TR. ER)	Filtre	Point nul	<ul style="list-style-type: none"> ● Ce réglage peut être effectué avec un disc de 8 cm ayant des microcuvettes sur un rayon supérieur à 75 mm. ● Charger le disc. (8 cm) ● Régler le mode d'essai. (*) ● Appuyer sur les touches TRACK FWD (▶▶) et PLAY (▶) dans cet ordre pour fermer les asservissements de mise au point et d'axe (l'asservissement d'alignement est en état ouvert). ● Appuyer sur la touche DISPLAY. et amener le capteur sur la piste extérieure du disc de 8 cm. Lors du déplacement du capteur, il est possible d'insérer un tournevis dans la fente de la plaque de réglage du filtre depuis le haut de l'appareil. (Fig. 3). ● Observer la forme d'onde à la broche 4 (TR. ER: erreur d'alignement) de TP1 avec un oscilloscope et à ce moment-là, insérer un filtre passe-bas de coupure 4 kHz (Fig. 2). ● Insérer le tournevis d'alignement dans la fente de réglage et le tourner afin de trouver le point nul (Photo-1).
	 <p style="text-align: center;">Fig. 2.</p>					

* Voir Page 51.

Etape No.	Réglage de l'oscilloscope		Points d'essai	Points de réglage	Éléments contrôlés/ spécifications de réglage	Procédure de réglage
	V	H				
4-2 Réglage du filtre (2) (avec un disc de 12 cm dont la durée de lecture est supérieure à 60 minutes)						
	1V/div	5 ms/div	TP1 Pin 4 (TR. ER)	Filtre	Point nul	<ul style="list-style-type: none"> ● Charger le disc. (durée de lecture supérieure à 60 minutes). ● Régler le mode d'essai. (*) ● Appuyer sur les touches TRACK FWD (▶▶) et PLAY (▶) dans cet ordre pour fermer les asservissements de mise au point et d'axe (l'asservissement d'alignement est en état ouvert). ● Appuyer sur la touche DISPLAY et amener le capteur sur la piste extérieure du disc. Lors du déplacement du capteur, il est possible d'insérer un tournevis dans la fente de la plaque de réglage du filtre depuis le haut de l'appareil. (Fig. 3). ● Observer la forme d'onde à la broche 4 (TR. ER: erreur d'alignement) de TP1 avec un oscilloscope et à ce moment-à, insérer un filtre passe-bas de coupure 4 kHz (Fig. 2). ● Insérer le tournevis d'alignement dans la fente de réglage et le tourner afin de trouver le point nul (Photo-1).
				Filtre	Amplitude maximum	<ul style="list-style-type: none"> ● Tourner lentement l'excitateur de filtre dans le sens des aiguilles d'une montre à partir du point nul et le régler au premier point où l'amplitude de la forme d'onde (signal d'erreur d'alignement) est maximum. (Voir photo-2).

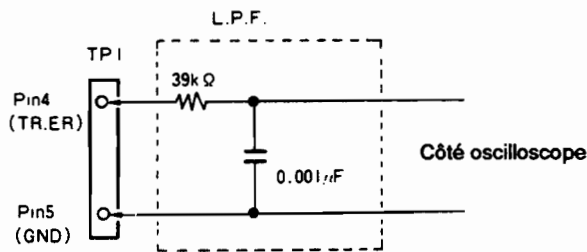


Fig. 2.

* Voir Page 51.

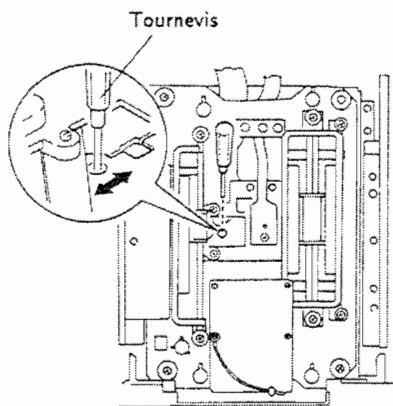


Fig. 3. Réglage du Filtre

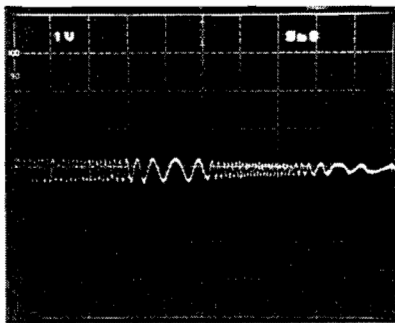


Photo-1 Point nul

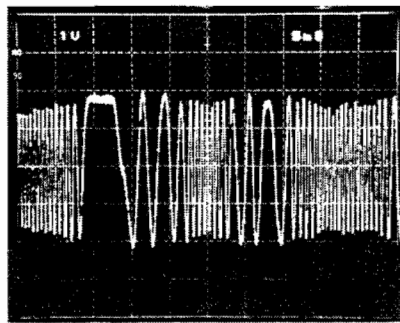


Photo-2 Amplitude maximum

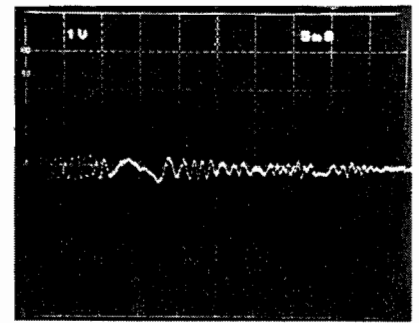
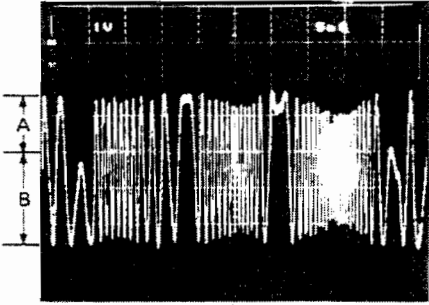
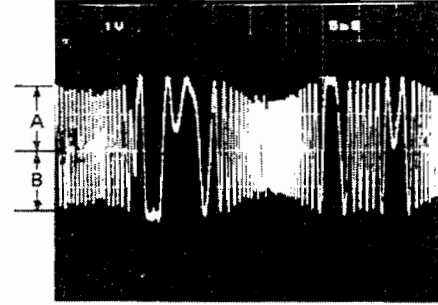


Photo-3 Hors du point nul

Etape No.	Réglage de l'oscilloscope		Points d'essai	Points de réglage	Éléments contrôlés/ spécifications de réglage	Procédure de réglage
	V	H				
5	Réglage de l'équilibre d'alignement					
	0.5V/div	5 msec/div	TP1 Pin 4 (TR. ER)	VR5 (TR. BL)		<ul style="list-style-type: none"> ● Charger le disc. ● Régler le mode d'essai. (*) ● Appuyer sur la touche DISPLAY et amener le chariot près de la piste centrale du disc. ● Appuyer sur les touches TRACK FWD (▶▶) et PLAY (▶) dans cet ordre pour faire tourner le disc. ● Observer la forme d'onde à la broche 4 (TR. ER: erreur d'alignement) de TP1 avec un oscilloscope. Et régler VR5 (TR. BL: équilibre d'alignement) afin d'éliminer les éléments CC de la forme d'onde d'erreur d'alignement.
			→			
	Photo-6				Photo-7	

* Voir Page 51.

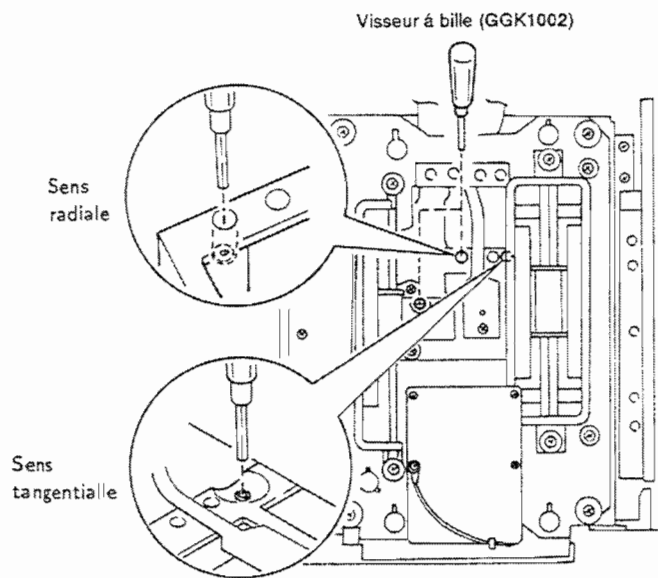


Fig. 4. Réglage Tangentiel

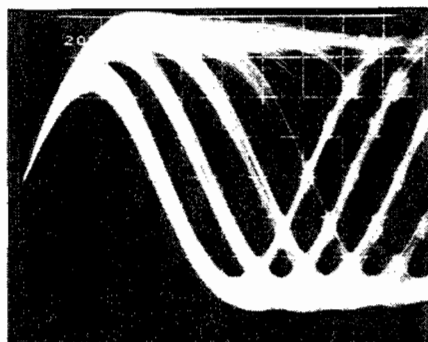


Photo-8

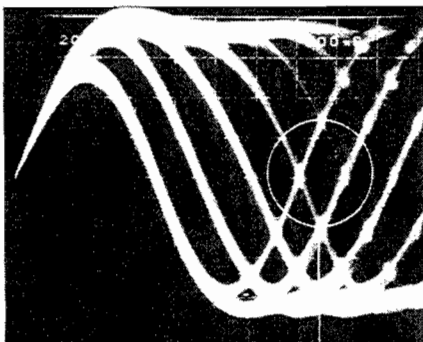


Photo-9

Pièce à observer

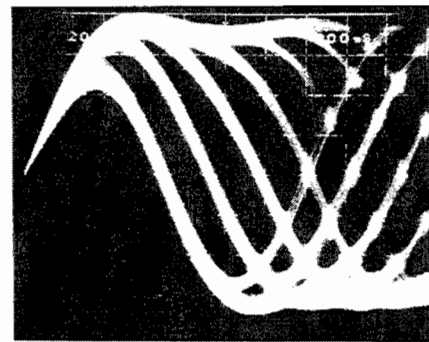
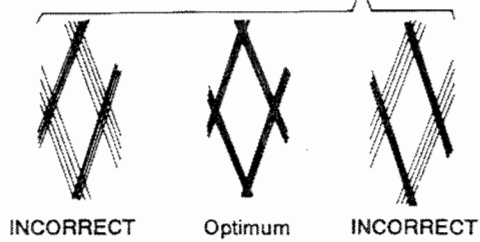
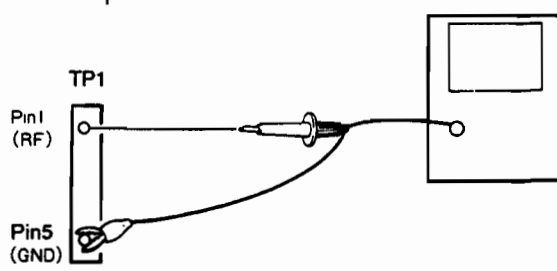


Photo-10



Etape No.	Réglage de l'oscilloscope		Points d'essai	Points de réglage	Éléments contrôlés/ spécifications de réglage	Procédure de réglage
	V	H				
6	Réglage tangentiel					
			TP 1 Pin 1 (Sortie RF)	Vis de réglage tangentiel	Point optimum de mire	<ul style="list-style-type: none"> ● Charger le disc. ● Régler le mode d'essai. (*) ● Appuyer sur la touche DISPLAY et amener le capteur à la piste centrale du disc. (Le placer à un endroit où la vis tangentielle peut être vue depuis le haut du mécanisme d'asservissement. (Voir Fig. 4.). ● Appuyer sur les touches TRACK FWD (▶▶), PLAY (▶) et PAUSE (▣) dans cet ordre pour fermer tous les asservissements. (Le témoin de pause s'allume). ● Observer la sortie RF broche 1 de TP 1 avec un oscilloscope et régler la vis tangentielle afin que la mire devienne claire. (Fig. 4.). ● Le point de réglage est situé vers la position médiane entre le point où la mire devient floue lorsque la vis tangentielle est tournée dans le sens des aiguilles d'une montre et le point où la mire devient floue lorsque la vis de réglage est tournée dans le sens inverse. <p>Observer la netteté d'ensemble de la forme d'onde et une des formes en diamant dans la mire (Photo-9). Le réglage optimum est obtenu au point où les lignes de la forme en diamant sont relativement fines.</p>
						 <p style="text-align: center;">Fig. 5</p>

* Voir Page 51.

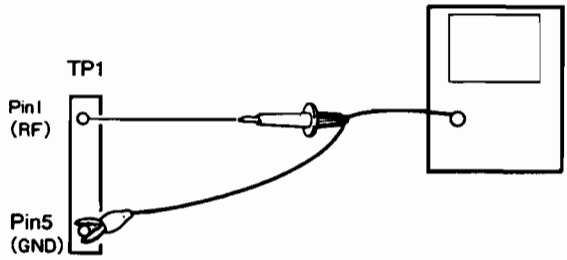
Etape No.	Réglage de l'oscilloscope		Points d'essai	Points de réglage	Eléments contrôlés/ spécifications de réglage	Procédure de réglage
	V	H				
7	Réglage radial					
			TP 1 Pin 1 (Sortie RF)	Vis de réglage radial	Point optimum de mire	<ul style="list-style-type: none"> ● Charger le disc. ● Régler le mode d'essai. (*) ● Appuyer sur la touche DISPLAY et amener le capteur à la piste centrale du disc. (Le placer à un endroit où la vis radiale peut être vue depuis le haut du mécanisme d'asservissement. (Voir Fig. 5).) ● Appuyer sur les touches TRACK FWD (▶▶), PLAY (▶) et PAUSE (■) dans cet ordre pour fermer tous les asservissements. (Le témoin de pause s'allume). ● Observer la sortie RF broche 1 de TP 1 avec un oscilloscope et régler la vis radiale afin que la mire devienne claire. (Fig. 4.). ● Le point de réglage est situé vers la position médiane entre le point où la mire devient floue lorsque la vis radiale est tournée dans le sens des aiguilles d'une montre et le point où la mire devient floue lorsque la vis de réglage est tournée dans le sens inverse. <p>Observer la netteté d'ensemble de la forme d'onde et une des formes en diamant dans la mire (Photo-9). Le réglage optimum est obtenu au point où les lignes de la forme en diamant sont relativement fines.</p> <ul style="list-style-type: none"> ● Effectuer alternativement, deux fois ou plus, les réglages tangentiel et radial.
						 <p>The diagram shows a test point labeled TP1 with two pins: Pin 1 (RF) and Pin 5 (GND). Two wires are connected to these pins and lead to an oscilloscope. One wire is connected to Pin 1 and the other to Pin 5.</p>

Fig. 5

* Voir Page 51.

Etape No.	Réglage de l'oscilloscope		Points d'essai	Points de réglage	Eléments contrôlés/ spécifications de réglage	Procédure de réglage
	V	H				
8	Contrôle du niveau RF (fréquence radio)					
			TP 1 Pin 1 (RF)	Contrôle	1,5V $\begin{smallmatrix} +0,2V \\ -0V \end{smallmatrix}$	<ul style="list-style-type: none"> ● Régler le mode d'essai. (*) ● Connecter la sonde de l'oscilloscope à la sortie RF broche 1 de TP 1 . ● Reproduire le disc, mesurer la tension c-c de la forme d'onde RF et confirmer qu'elle devient 1,5V $\begin{smallmatrix} +0,2V \\ -0V \end{smallmatrix}$. ● Ajuster VR 10 si la tension ne devient pas 1,5V $\begin{smallmatrix} +0,2V \\ -0V \end{smallmatrix}$.
			TP 1 Pin 1 (RF)	VR 10	1,5V $\begin{smallmatrix} +0,2V \\ -0V \end{smallmatrix}$	

* Voir Page 51.

Etape No.	Réglage de l'oscilloscope		Points d'essai	Points de réglage	Éléments contrôlés/ spécifications de réglage	Procédure de réglage
	V	H				
9	Réglage du gain de mise au point					
	CH1 (X) , CH2 (Y) 20 mV/div, 5 mV/div (Sonde 10:1)		Axe X: TP1 Pin 5 (FO. IN) Axe Y: TP1 Pin 6 (FO. ER)	VR3 (FO. GA)	Différence de phase 90°	<ul style="list-style-type: none"> ● L'alimentation étant coupée, connecter l'oscilloscope et l'oscillateur comme indiqué sur la Fig. 6. ● Régler le mode de lecture normal. ● Mettre l'oscillateur sous tension et le régler pour sortir un signal 1 Vc-c, 1,2 kHz. <p>Remarque: (Certains oscillateurs sortent CC lorsqu'ils sont mis sous tension. Dans ce cas, connecter l'oscillateur après l'avoir mis sous tension).</p> <ul style="list-style-type: none"> ● Ajuster VR3 (FO. GA; gain de mise au point) afin que la forme d'onde de choc sur l'oscilloscope devienne un cercle horizontal (différence de phase 90°).

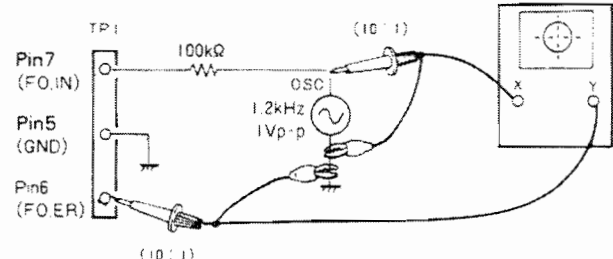
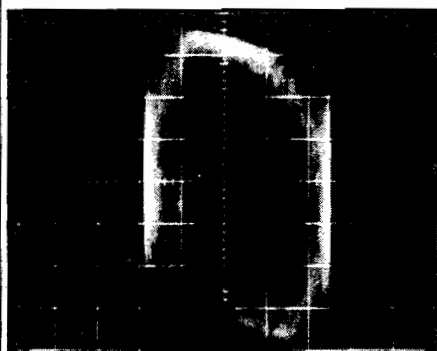
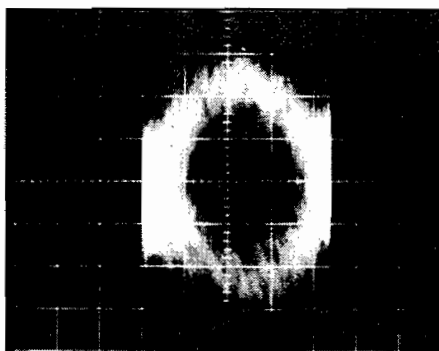


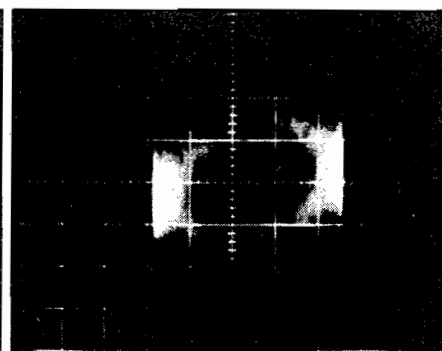
Fig. 6.



Gain élevé
Photo-11



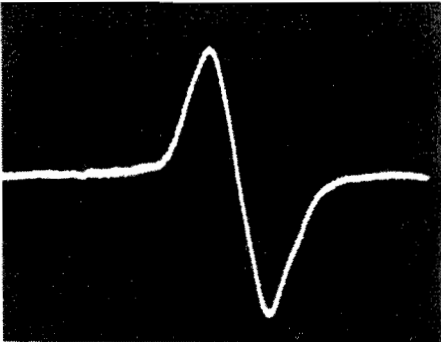
Gain optimum
Photo-12



Gain faible
Photo-13

Etape No.	Réglage de l'oscilloscope		Points d'essai	Points de réglage	Éléments contrôlés/ spécifications de réglage	Procédure de réglage
	V	H				
10	Réglage du gain d'alignement					
	CH1 (X), CH2 (Y) 50 mV/div, 5 mV/div (Sonde 10:1)		Axe X: TP1 Pin 3 (TR. IN) Axe Y: TP1 Pin 2 (TR. ER)	VR4 (TR. GA)	Différence de phase 90°	<ul style="list-style-type: none"> ● L'alimentation étant coupée, connecter l'oscilloscope et l'oscillateur comme indiqué sur la Fig. 7. ● Régler le mode de lecture normal. ● Mettre l'oscillateur sous tension et le régler pour sortir un signal 2 Vc-c, 1 kHz. Remarque: (Certains oscillateurs sortent CC lorsqu'ils sont mis sous tension. Dans ce cas, connecter l'oscillateur après l'avoir mis sous tension). ● Ajuster VR4 (TR. GA: gain d'alignement) afin que la forme d'onde de choc sur l'oscilloscope devienne un cercle horizontal (différence de phase 90°).
					<p style="text-align: right;">Fig. 7.</p>	
	<p style="text-align: center;">Gain élevé Photo-14</p>		<p style="text-align: center;">Gain optimum Photo-15</p>		<p style="text-align: center;">Gain faible Photo-16</p>	
11	Réglage de la fréquence de relaxation du VCO (oscillateur à fréquence réglée par variation de tension)					
			TP 2 Pin 2		Fréquence 4,275 MHz ± 0,025 MHz	<ul style="list-style-type: none"> ● Régler le mode d'essai. (*) ● Coupler ASY et les fils GND en utilisant un tournevis à fente ou objet similaire. ● Connecter le fréquencemètre (gamme 10 MHz) à la broche 2 de TP 2. ● Ajuster VR8 (VCO. A) afin que le fréquencemètre indique 4,275 MHz ± 0,025 MHz. Remarque: Ajuster dans le mode d'arrêt.

* Voir Page 51.

Etape No.	Réglage de l'oscilloscope		Points d'essai	Points de réglage	Éléments contrôlés/ spécifications de réglage	Procédure de réglage
	V	H				
12	Contrôle d'erreur de mise au point					
	1V/div	2 ms/div	TP1 Pin 6 (FO. ER)	Contrôle	Forme d'onde	<ul style="list-style-type: none"> ● Régler le mode d'essai. (*) ● Connecter la broche 7 FO. IN (entrée de mise au point) de TP1 à GND. ● Appuyer sur la touche TRACK FWD et contrôler la forme d'onde à la broche 6 FO. ER (erreur de mise au point) de TP1 avec l'oscilloscope.
						 <p>Erreur de mise au point Photo-17</p>

* Voir Page 51.

7. AJUSTES

Realice los siguientes ajustes en el orden indicado:

● Ajustes

1. Ajuste de compensación del error de seguimiento, del error de foco y de RF
2. Ajuste de compensación del retorno de seguimiento
3. Comprobación de la sincronización del foco y del eje
4. Ajuste de la rejilla
5. Ajuste del equilibrio del seguimiento
6. Ajuste tangencial
7. Ajuste radial
8. Comprobación del nivel de RF
9. Ajuste de la ganancia de foco
10. Ajuste de la ganancia de seguimiento
11. Ajuste de la frecuencia propia del VCO (oscilador controlado por tensión)
12. Método de comprobación del error de foco

● Dispositivos de Medición

1. Osciloscopio de doble trazo
2. Medidor de potencia lumínica
3. Disco de prueba YEDS-7
4. Filtro de ajuste de foco y seguimiento
5. Filtro de paso de banda para el ajuste de la ganancia de bucle.
6. Generador de señales
7. Destornillador de la rejilla
8. Herramientas de uso general
9. Disco disponible comercialmente (de 8 cm y de 12 cm)
10. Llave hex.(GGK 1002, 1.5 mm)

● Modo de prueba

Activación y desactivación del modo de prueba

- ① Para activar el modo de prueba, ponga en ON el interruptor de alimentación con el puente del modo de prueba cortocircuitado.
- ② El modo de prueba se desactivará poniendo el interruptor de alimentación en OFF.

Las funciones de las teclas en el modo de prueba se describen en la tabla 1.

● Descripción de los Resistores Variables Empleados para el Ajuste

- VR2: Compensación de RF (RF. OF)
 VR3: Ganancia de foco (FO. GA)
 VR4: Ganancia de seguimiento (TR. GA)
 VR5: Equilibrio de seguimiento (TR. BL)
 VR6: Compensación del error de foco (FO. OF)
 VR7: Compensación del error de seguimiento (TE. OF)
 VR8: Contador de frecuencias del oscilador controlado por tensión (VCOA)
 VR9: Compensación del retorno de seguimiento (TR. OF)
 VR10: Nivel de RF (RF.LEV)

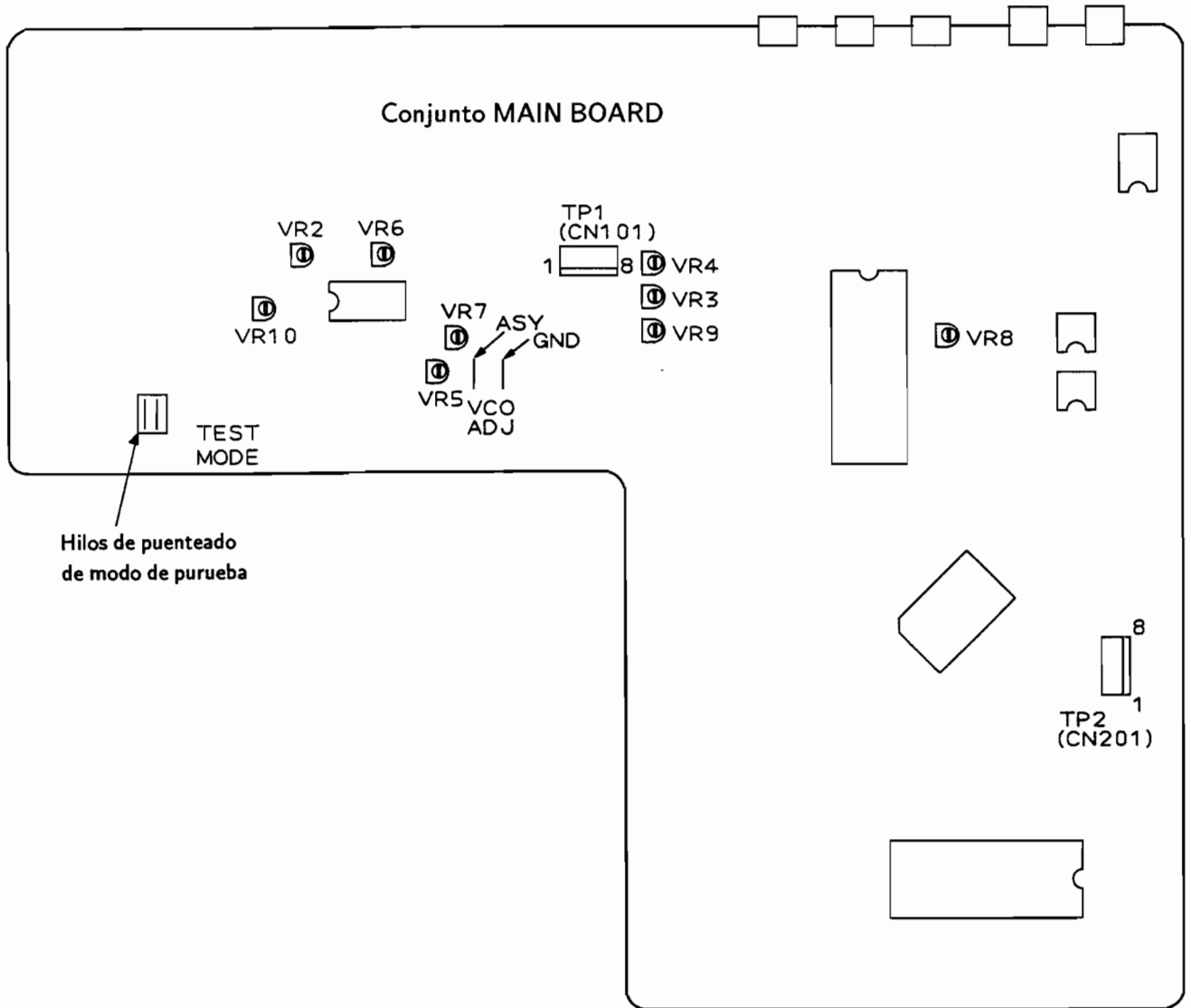
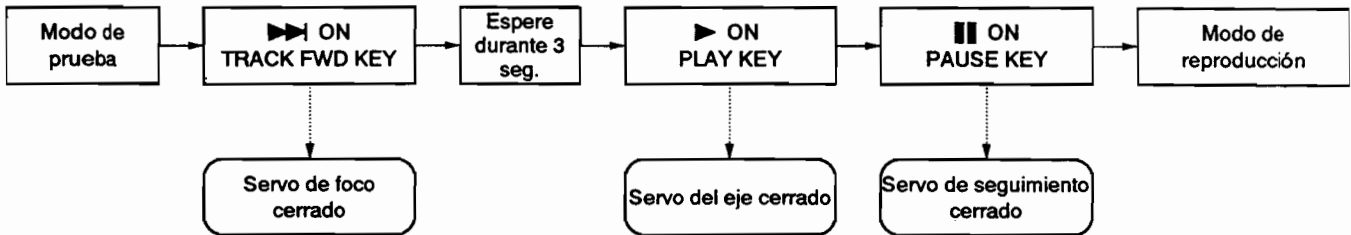


Fig.1 Punt de ajuste

En el modo de prueba, la apertura y cerrado de los servos se efectúa independientemente. Por lo tanto, para establecer el modo de reproducción se deben cerrar los servos en orden serial. Recuerde que en el modo de prueba no se puede establecer el modo de reproducción pulsando simplemente la tecla PAUSE (||).

Por ejemplo, para establecer el modo de reproducción partiendo del modo de parada pulse las teclas siguientes en el orden indicado.



* En el modo de prueba los servos siguen un orden serial.

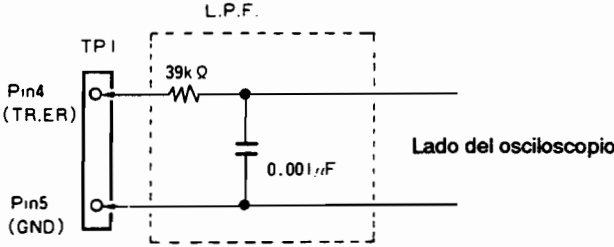
● **Función de Cada Tecla en el Modo de Prueba**

Símbolo	Tecla	Función durante el modo de prueba	Explicación
▶▶	TRACK FWD	Cerrar el servo del foco	Enciende el diodo laser y mueve el actuador del foco en dirección vertical para cerrar el servo del foco.
▶	PLAY	Cerrar el servo del eje	Después de arrancar el motor del eje, cierre el servo en el modo CLV-H.
	PAUSE	Abrir/cerrar el servo de seguimiento	Ejecuta una conmutación. Al pulsar esta tecla se cierra el servo de seguimiento y la unidad entra en el modo de reproducción (los servos del foco y del eje deben estar cerrados previamente). En ese momento se enciende el indicador PAUSE. Si se la pulsa nuevamente, se abre el servo de seguimiento.
	OUTPUT	Movimiento en retroceso (hacia dentro) del carro	Mueve el carro hacia dentro a alta velocidad (aprox. 1 cm/seg.). Dado que no existe un dispositivo de seguridad que detenga el carro, asegúrese de detenerlo manualmente a tiempo.
	DISPLAY	Movimiento en avance (hacia fuera) del carro	Mueve el carro hacia fuera a alta velocidad (aprox. 1 cm/seg.). Dado que no existe un dispositivo de seguridad que detenga el carro, asegúrese de detenerlo manualmente a tiempo.
■	STOP	Parada	Detiene todos los servos y hace que la unidad vuelva a su estado inicial.
▲	OPEN/CLOSE	Abrir/cerrar la bandeja del disco	Abre y cierra la bandeja del disco. Sin embargo, el lector no vuelve a la posición de reposo cuando se abre la bandeja y tampoco se mueve al cerrarse la bandeja.

Tabla 1.

Paso	Margen del osciloscopio		Puntos de prueba	Puntos de ajuste	Item a probar/Especif. de ajuste	Procedimiento de ajuste
	V	H				
1	Ajuste de compensación del error de seguimiento, del error de foco y de RF					
		TP1	TP1 Pin 4 (TR. ER)	VR7 (TE. OF)	0V ± 50 mV	<ul style="list-style-type: none"> ● Establezca el modo de prueba. (*) ● Ajuste VR7 (TE. OF: compensación del error de seguimiento) de forma que la tensión en el contacto 4 (TE: error de seguimiento) de TP1 sea 0V ± 50 mV. ● Ajuste VR6 (FO. OF: compensación del error de foco) de forma que la tensión en el contacto 6 (FO. ER: error de foco) de TP1 sea 0V ± 50 mV. ● Ajuste VR2 (RF. OF: compensación de RF) de forma que la tensión de salida de RF en el contacto 1 de TP 1 sea 100 mV ± 50 mV.
		TP1	TP1 Pin 6 (FO. ER)	VR6 (FO.OF)	0V ± 50 mV	
		TP1	TP 1 Pin 1 (RF)	VR2 (RF. OF)	100 mV ± 50 mV	
2	Ajuste de compensación del retorno de seguimiento					
		TP1	TP1 Pin 2 (TR. RT)	VR9 (TR. OF)	0V ± 10 mV	<ul style="list-style-type: none"> ● Establezca el modo de prueba. (*) ● Ajuste VR9 (TR. OF: compensación del retorno de seguimiento) de forma que la tensión en el contacto 2 (TR. RT: retorno de seguimiento) de TP1 sea 0V ± 10 mV.
3	Comprobación de la sincronización del foco y del eje					
	V 0.5V/div	H 100 msec /div	TP 1 Pin 1 (Salida de RF)		Salida de RF Rotación en sentido horario	<ul style="list-style-type: none"> ● Cargue el disco. ● Establezca el modo de prueba. (*) ● Aproxime el lector al centro del disco usando la tecla DISPLAY. Asegúrese de efectuar esta operación. ● Observe la salida de RF por el contacto 1 de TP 1 con un osciloscopio y confirme que la señal de RF sea emitida al pulsar la tecla TRACK FWD (▶▶). ● Pulse la tecla PLAY (▶) y confirme que el disco gira en sentido horario a aproximadamente la velocidad normal (unos 300 rpm por estar el lector cerca del centro del disco) sin que corra descontroladamente o en dirección inversa.

* Vea la Página 66.

Paso	Margen del osciloscopio		Puntos de prueba	Puntos de ajuste	Item a probar/Especif. de ajuste	Procedimiento de ajuste
	V	H				
4-1	Ajuste de la rejilla (1) (con un disco de 8 cm)					
	1V/div	5 ms/div	TP1 Pin 4 (TR. ER)	Rejilla	Punto nulo	<ul style="list-style-type: none"> ● Este ajuste puede realizarse utilizando un disco de 8 cm con hoyos sobre un diámetro de 75 mm. ● Cargue el disco. (8 cm) ● Establezca el modo de prueba. (*) ● Pulse las teclas TRACK FWD (▶▶) y PLAY (▶) en este orden para cerrar los servos del foco y del eje (el servo de seguimiento estará abierto). ● Pulse la tecla DISPLAY y mueva el lector a la pista externa del disco de 8 cm. Cuando mueva el lector, será posible introducir un destornillador en la ranura de la placa de ajuste de la rejilla desde la parte de arriba de la unidad. (Fig. 3) ● Observe la forma de la onda por el contacto 4 (TR. ER: error de seguimiento) de TP1 con un osciloscopio y, en ese momento, introduzca un filtro de corte pasabajos de 4 kHz. (Fig. 2) ● Introduzca el destornillador de seguimiento en la ranura de ajuste y gírelo de forma que encuentre el punto nulo (Foto-1).
 <p style="text-align: center;">Fig. 2.</p>						

* Vea la Página 66.

Paso	Margen del osciloscopio		Puntos de prueba	Puntos de ajuste	Item a probar/Especif. de ajuste	Procedimiento de ajuste
	V	H				
4-2	Ajuste de la rejilla (2) (con un disco de 12 cm reproduciendo durante más de 60 minutos)					
	1V/div	5 ms/div	TP1 Pin 4 (TR. ER)	Rejilla	Punto nulo	<ul style="list-style-type: none"> ● Cargue el disco (reproduciendo durante más de 60 minutos). ● Establezca el modo de prueba. (*) ● Pulse las teclas TRACK FWD (▶▶) y PLAY (▶) en este orden para cerrar los servos del foco y del eje (el servo de seguimiento estará abierto). ● Pulse la tecla DISPLAY y mueva el lector a la pista externa del disco. Cuando mueva el lector, será posible introducir un destornillador en la ranura de la placa de ajuste de la rejilla desde la parte de arriba de la unidad. (Fig. 3) ● Observe la forma de la onda por el contacto 4 (TR. ER: error de seguimiento) de TP1 con un osciloscopio y, en ese momento, introduzca un filtro de corte pasabajos de 4 kHz. (Fig. 2) ● Introduzca el destornillador de seguimiento en la ranura de ajuste y gírelo de forma que encuentre el punto nulo. (Foto-1)
				Rejilla	Amplitud máxima	<ul style="list-style-type: none"> ● Gire el destornillador de la rejilla lentamente en sentido antihorario a partir del punto nulo y deténgase en el primer punto donde la amplitud de la onda (señal de error de seguimiento) sea máxima. (Vea Foto-2)

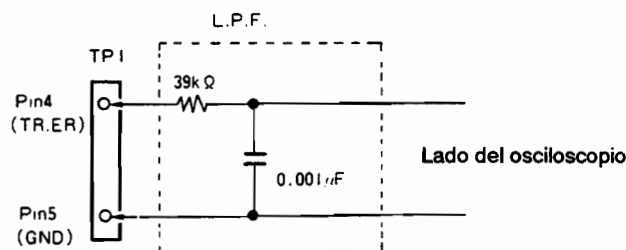


Fig. 2.

* Vea la Página 66.

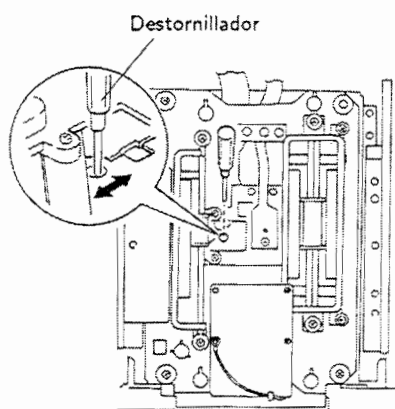


Fig. 3. Ajuste de la Rejilla

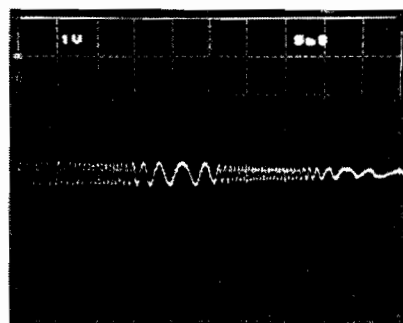


Foto-1 Punto nulo

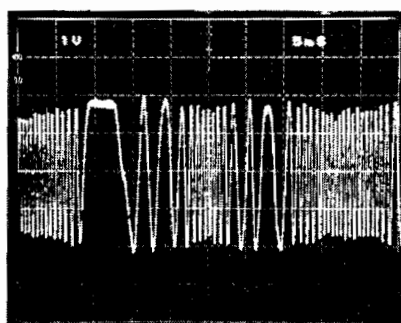


Foto-2 Amplitud máxima

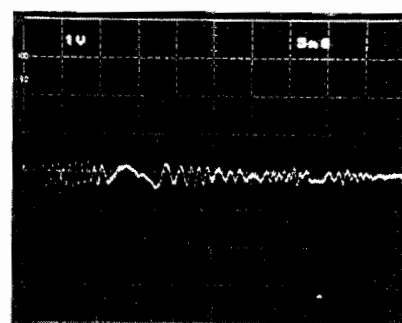
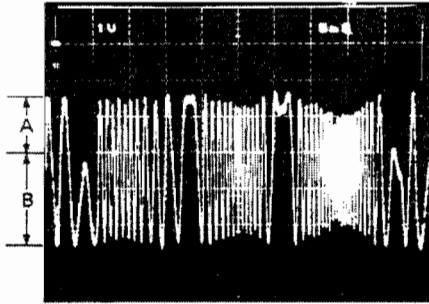

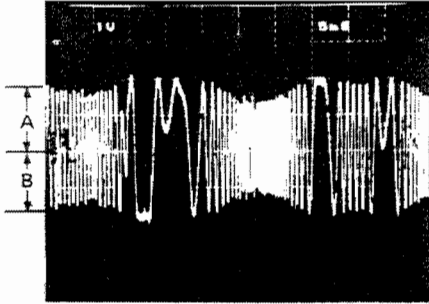


Foto-3 Fuera del punto nulo

Paso	Margen del osciloscopio		Puntos de prueba	Puntos de ajuste	Item a probar/Especif. de ajuste	Procedimiento de ajuste
	V	H				
5	Ajuste del equilibrio del seguimiento					
	0.5V/div	5 msec/div	TP1 Pin 4 (TR. ER)	VR5 (TR. BL)		<ul style="list-style-type: none"> ● Cargue el disco ● Establezca el modo de prueba. (*) ● Pulse la tecla DISPLAY y mueva el carro hasta cerca de la pista central del disco. ● Pulse las teclas TRACK FWD (▶▶) y PLAY (▶) en ese orden para hacer girar el disco. ● Observe la forma de la onda por el contacto 4 (TR. ER: error de seguimiento) de TP1 con un osciloscopio y ajuste el VR5 (TR. BL: equilibrio de seguimiento) de forma que desaparezcan los elementos de CC de la onda del error de seguimiento.
						
			Foto-6	Foto-7		

* Vea la Página 66.

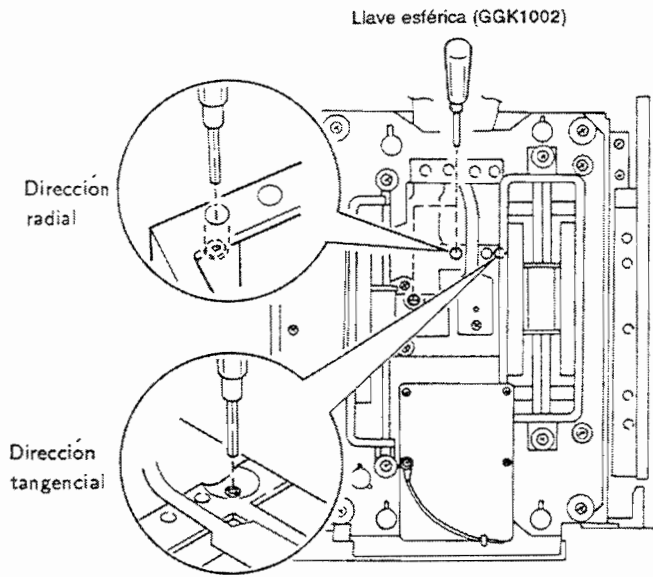


Fig. 4. Ajuste Tangencial

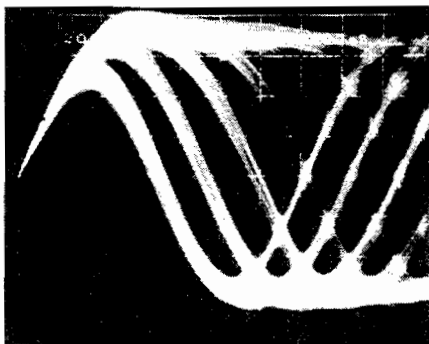


Foto-8

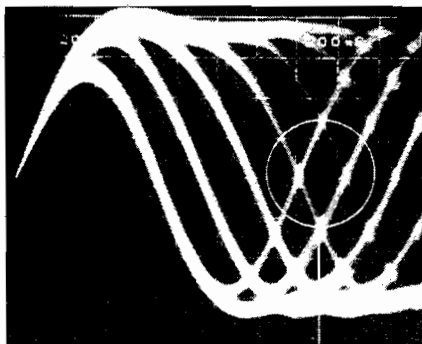


Foto-9

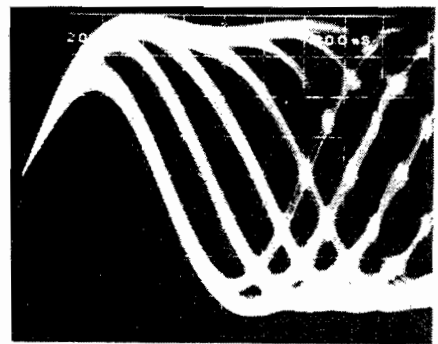
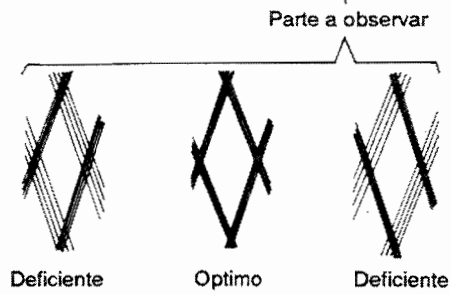
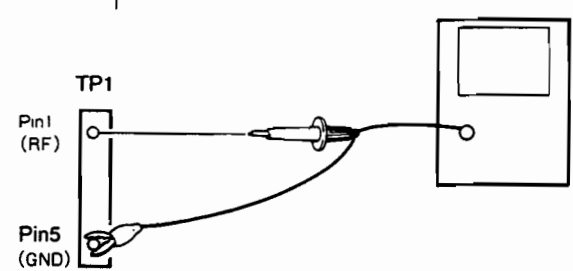
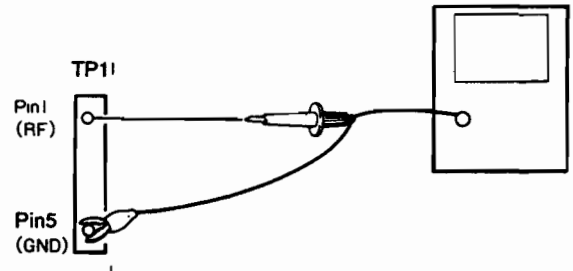


Foto-10



Paso	Margen del osciloscopio		Puntos de prueba	Puntos de ajuste	Item a probar/Especif. de ajuste	Procedimiento de ajuste
	V	H				
6	Ajuste tangencial					<ul style="list-style-type: none"> ● Cargue el disco. ● Establezca el modo de prueba. (*) ● Pulse la tecla DISPLAY y mueva el lector a la pista central del disco (colóquelo en un lugar tal que el tornillo de ajuste tangencial pueda verse desde arriba del servomecanismo. (Vea la Fig. 4) ● Pulse las teclas TRACK FWD (▶▶), PLAY (▶) y PAUSE (■) en este orden para cerrar todos los servos. (Se enciende el indicador de pausa). ● Observe la salida de RF por el contacto 1 de TP 1 con un osciloscopio y ajuste el tornillo tangencial de forma que la figura del ojo se vea claramente. (Fig. 4) ● El punto de ajuste se encuentra cerca del punto medio entre el punto donde la figura del ojo se enturbia al girar el tornillo tangencial en sentido horario y el punto donde la figura del ojo se enturbia al girar el tornillo de ajuste en sentido antihorario. Observe la claridad general de la onda y una de las figuras del diamante en la figura del ojo (foto-9). El ajuste óptimo se obtiene donde las líneas de la figura del diamante son relativamente delgadas.
			TP 1 Pin 1 (Salida de RF)	Tornillo de ajuste tangencial	Punto óptimo de la figura del ojo	 <p style="text-align: center;">Fig. 5</p>

* Vea la Página 66.

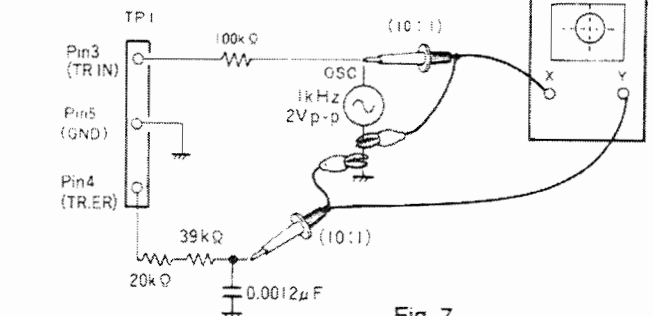
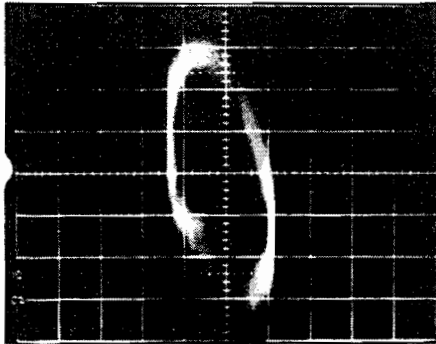
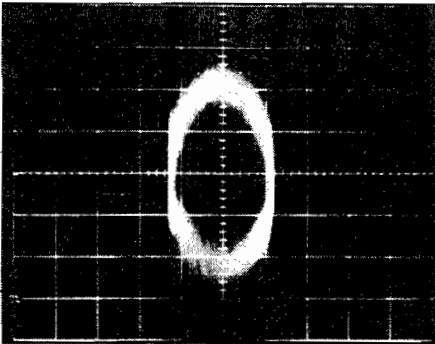
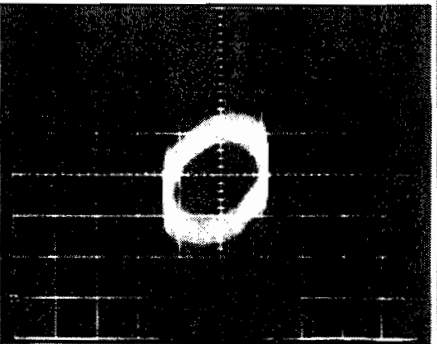
Paso	Margen del osciloscopio		Puntos de prueba	Puntos de ajuste	Item a probar/Especif. de ajuste	Procedimiento de ajuste
	V	H				
7	Ajuste radial					<ul style="list-style-type: none"> ● Cargue el disco. ● Establezca el modo de prueba. (*) ● Pulse la tecla DISPLAY y mueva el lector a la pista central del disco (colóquelo en un lugar tal que el tornillo de ajuste tangencial pueda verse desde arriba del servomecanismo. (Vea la Fig. 5) ● Pulse las teclas TRACK FWD (▶▶), PLAY (▶) y PAUSE (■) en este orden para cerrar todos los servos. (Se enciende el indicador de pausa). ● Observe la salida de RF por el contacto 1 de TP 1 con un osciloscopio y ajuste el tornillo radial de forma que la figura del ojo se vea claramente. (Fig. 4) ● El punto de ajuste se encuentra cerca del punto medio entre el punto donde la figura del ojo se enturbia al girar el tornillo radial en sentido horario y el punto donde la figura del ojo se enturbia al girar el tornillo de ajuste en sentido antihorario. Observe la claridad general de la onda y una de las figuras del diamante en la figura del ojo (foto-9). El ajuste óptimo se obtiene donde las líneas de la figura del diamante son relativamente delgadas. ● Efectúe los ajustes tangencial y radial alternativamente dos o más veces.
			TP 1 Pin 1 (Salida de RF)	Tornillo de ajuste radial	Punto óptimo de la figura del ojo	 <p style="text-align: center;">Fig. 5</p>

* Vea la Página 66.

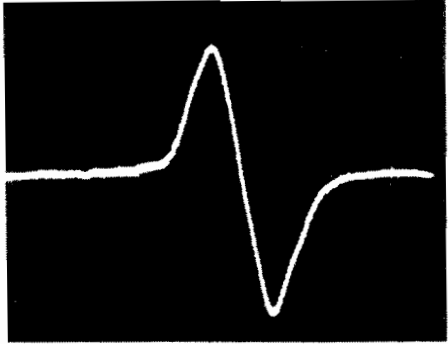
Paso	Margen del osciloscopio		Puntos de prueba	Puntos de ajuste	Item a probar/Especif. de ajuste	Procedimiento de ajuste
	V	H				
8	Comprobación del nivel de RF					
			TP 1 Pin 1 (RF)	Comprobación	1.5V $\begin{smallmatrix} +0.2V \\ -0V \end{smallmatrix}$	<ul style="list-style-type: none"> ● Establezca el modo de prueba. (*) ● Conecte la sonda del osciloscopio al contacto 1 (salida de RF) de TP 1. ● Reproduzca el disco, mida la tensión p-p de la onda de RF y confirme que sea 1.5V $\begin{smallmatrix} +0.2V \\ -0V \end{smallmatrix}$. ● Ajuste VR 10 si la tensión no es 1.5V $\begin{smallmatrix} +0.2V \\ -0V \end{smallmatrix}$.
			TP 1 Pin 1 (RF)	VR 10	1.5V $\begin{smallmatrix} +0.2V \\ -0V \end{smallmatrix}$	

* Vea la Página 66.

Paso	Margen del osciloscopio		Puntos de prueba	Puntos de ajuste	Item a probar/Especif. de ajuste	Procedimiento de ajuste
	V	H				
9	Ajuste de la ganancia de foco					
	CH1 (X) , CH2 (Y) 20 mV/div, 5 mV/div (Sonda 10:1)		Eje X: TP1 Pin 5 (FO. IN) Eje Y: TP1 Pin 6 (FO. ER)	VR3 (FO. GA)	Diferencia de fase de 90°	<ul style="list-style-type: none"> ● Con la unidad apagada, conecte el osciloscopio y el oscilador como muestra la Fig. 6. ● Establezca el modo de reproducción normal. ● Encienda el oscilador y ajústelo para que emita una señal de 1,2 kHz, 1 Vp-p. <p>Nota: Algunos osciladores emiten CC al ser encendidos. En este caso, encienda el oscilador antes de conectarlo.</p> <ul style="list-style-type: none"> ● Ajuste VR3 (FO. GA: ganancia de foco) de forma que la onda de resurgimiento en el osciloscopio se convierta en un círculo horizontal (diferencia de fase de 90°).
						Fig. 6.
Alta ganancia Foto-11		Ganancia óptima Foto-12		Baja ganancia Foto-13		

Paso	Margen del osciloscopio		Puntos de prueba	Puntos de ajuste	Item a probar/Especif. de ajuste	Procedimiento de ajuste
	V	H				
10	Ajuste de la ganancia de seguimiento					<ul style="list-style-type: none"> ● Con la unidad apagada, conecte el osciloscopio y el oscilador como muestra la Fig. 7. ● Establezca el modo de reproducción normal. ● Encienda el oscilador y ajústelo para que emita una señal de 1 kHz, 2 Vp-p. <p>Nota: Algunos osciladores emiten CC al ser encendidos. En este caso, encienda el oscilador antes de conectarlo.</p> <ul style="list-style-type: none"> ● Ajuste VR4 (TR. GA: ganancia de seguimiento) de forma que la onda de resurgimiento en el osciloscopio se convierta en un círculo horizontal (diferencia de fase de 90°).
	CH1 (X), CH2 (Y) 50 mV/div, 5 mV/div (Sonda 10:1)		Eje X: TP1 Pin 3 (TR. IN) Eje Y: TP1 Pin 2 (TR. ER)	VR4 (TR. GA)	Diferencia de fase de 90°	 <p style="text-align: right;">Fig. 7.</p>
						
	Alta ganancia Foto-14	Ganancia óptima Foto-15	Baja ganancia Foto-16			
11	Ajuste de la frecuencia propia del oscilador controlado por tensión					<ul style="list-style-type: none"> ● Establezca el modo de prueba. (*) ● Ponga en derivación los puentes del ASY y GND empleando un destornillador de cabeza ranurada u otra herramienta similar. ● Conecte el contador de frecuencias (margen de 10 MHz) al contacto 2 de TP 2. ● Ajuste VR8 (VCO. A) de forma que en el contador de frecuencias se lea 4,275 MHz \pm 0,025 MHz. <p>Nota: Ajuste con la unidad en el modo de parada</p>
			TP 2 Pin 2		Frecuencia 4,275 MHz \pm 0,025 MHz	

* Ve a la Página 66.

Paso	Margen del osciloscopio		Puntos de prueba	Puntos de ajuste	Item a probar/Especif. de ajuste	Procedimiento de ajuste
	V	H				
12	Comprobación del error de foco					
	1V/div	2 ms/div	TP1 Pin 6 (FO. ER)	Comprobación	Forma de onda	<ul style="list-style-type: none"> ● Establezca el modo de prueba. (*) ● Conecte a tierra el contacto 7 (FO. IN: entrada de foco) de TP1. ● Pulse la tecla TRACK FWD y compruebe la forma de la onda en el contacto 6 (FO. ER: error de foco) de TP1 con un osciloscopio.
 <p style="text-align: center;">Error de foco Foto-17</p>						

* Vea la Página 66.

8. IC INFORMATION

- The information shown in the list is basic information and may not correspond exactly to that shown in the schematic diagrams.

8.1 PD0116A (IC513)

• DIGITAL FILTER

Pin Function Table

Pin No.	Pin Name	I/O	Pin Function															
1	DATA	I	Serial data input (16-bit, 2 complement, MSB first)															
2	BCK	I	Bit clock input for input data															
3	CKS	I	XIN (master clock) frequency selection H=384 fs, L=256 fs															
4	(NC)	(I)																
5	CKEN	I	Crystal oscillation circuit operation control H=Oscillation, L=Stop															
6	XIN	I	Crystal oscillation circuit input or external clock input															
7	XOUT	O	Crystal oscillation circuit output															
8	VSS1	–	GND terminal 1															
9	CKOUT	O	Master clock output (Frequency is the same as XIN)															
10	CHS	I	Playback data channel selection (During 1 ch playback mode) H=Lch, L=Rch															
11	MDCK	I	Clock input for microprocessor data															
12	MDATA	I	Microprocessor data input															
13	MDLE	I	Latch enable signal input for microprocessor data															
14	RST	I	System reset H=Normal operation, L=Reset															
15	LRS	I	LR clock polarity selection <table border="1" style="margin-left: 20px;"> <tr> <td rowspan="2">LRS</td> <td colspan="2">LRCK</td> </tr> <tr> <td>H</td> <td>L</td> </tr> <tr> <td>H</td> <td>Lch</td> <td>Rch</td> </tr> <tr> <td>L</td> <td>Rch</td> <td>Lch</td> </tr> </table>	LRS	LRCK		H	L	H	Lch	Rch	L	Rch	Lch				
LRS	LRCK																	
	H	L																
H	Lch	Rch																
L	Rch	Lch																
16	OBS1	I	Output data bit length selection <table border="1" style="margin-left: 20px;"> <tr> <td>OBS1</td> <td>OBS2</td> <td>Bit length</td> </tr> <tr> <td>H</td> <td>H</td> <td>16</td> </tr> <tr> <td>H</td> <td>L</td> <td>18</td> </tr> <tr> <td>L</td> <td>H</td> <td>20</td> </tr> <tr> <td>L</td> <td>L</td> <td>19+1</td> </tr> </table>	OBS1	OBS2	Bit length	H	H	16	H	L	18	L	H	20	L	L	19+1
OBS1	OBS2	Bit length																
H	H	16																
H	L	18																
L	H	20																
L	L	19+1																
17	OBS2	I																
18	SMUTE	I	Soft mute control H=OFF, L=ON															
19	IPFS	I	Interpolation function selection Fixed to L															
20	PLYS	I	Playback channel mode selection H=2ch playback, L=1ch playback															
21	VSS2	–	GND terminal 2															
22	VDD	–	+5V power supply terminal															
23	RDOUT	O	Rch serial data output (During 1ch playback mode, serial data output) (2 complement, MSB first)															
24	LDOUT	O	Lch serial data output (During 1ch playback mode, "L" fixed output) (2 complement, MSB first)															
25	WOUT	O	Word clock output															
26	BOUT	O	Bit clock output for output data															
27	MDS	I	Mode setting method selection H=Terminal control, L=Microprocessor control															
28	LRCK	I	LR clock input															

*Input terminals other than XIN come with pull-up resistor.

9. DISASSEMBLY

9.1 PLACING THE ANALOG BOARD ASSEMBLY UPRIGHT (PD-95 only)

1. Remove the connectors. (5 in front and 4 behind)
 3 from the audio transformer (A)
 2 from the main board (B)
 1 from both analog boards-2 altogether (C)
 1 from the L and R jacks respectively-2 altogether (D)
2. Remove the ground lead wire.
3. Remove the screws of the board.
4. Remove the audio case.
5. Insert the analog board assembly into the holder of the front panel, and place it upright.
6. Re-insert the connectors.
7. When placing the analog board upright, ground one ground wire to the plate of the unit using an alligator clip extension cable.

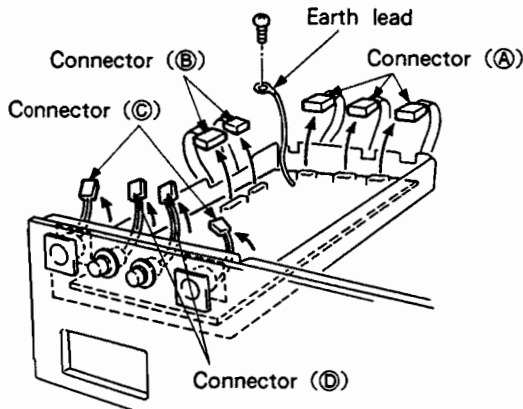


Fig. 1

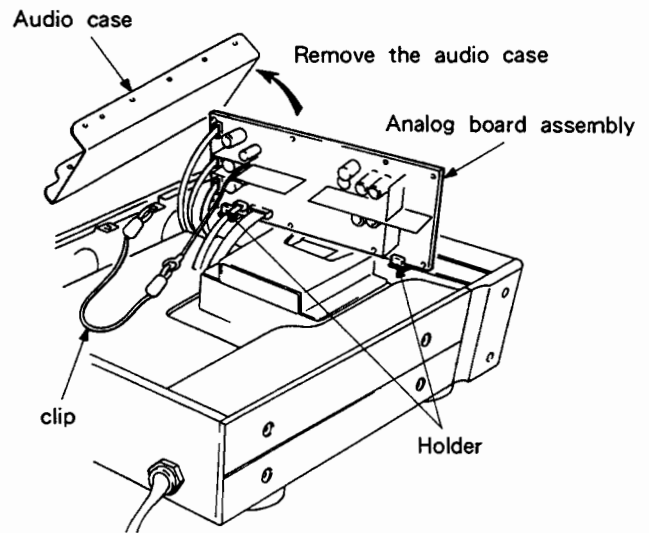


Fig. 2

9.2 PLACING THE MAIN BOARD ASSEMBLY UPRIGHT

Perform this after removing the analog board. (PD-95 only)

1. Remove the two screws ① of the DIGITAL OUT section on the rear side.
2. Remove all the screws of the main board assembly.
3. Remove the flexible cable from the input.
 (Be especially careful as this cable breaks easily.)
4. Insert the main board assembly into the slit of the base plate.
5. Re-insert the flexible cable and connectors.

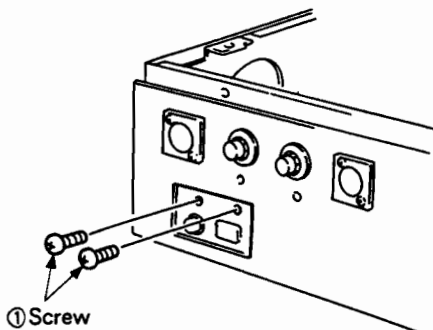


Fig. 3

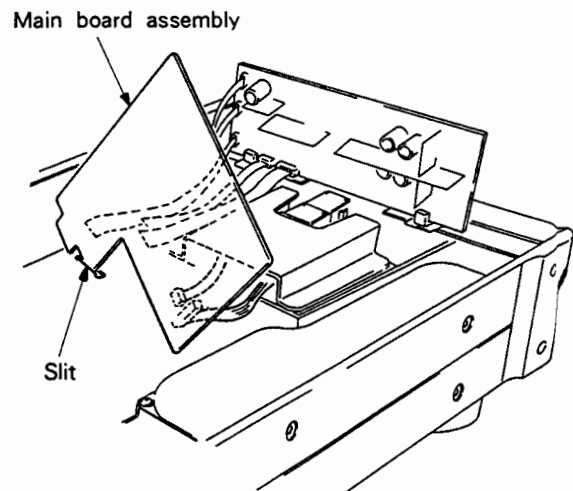
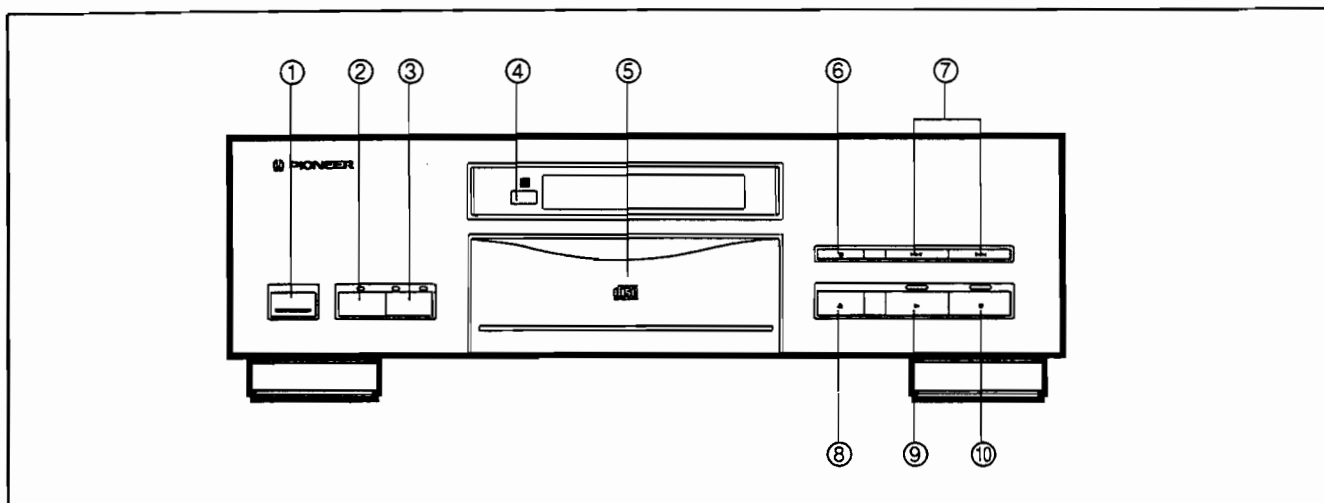


Fig. 4

10. PANEL FACILITIES



- ① **POWER** switch
- ② **DISPLAY** button and **OFF** indicator
- ③ **OUTPUT** button and **DIGITAL/ANALOG** indicators
(PD-S95: **OPTICAL/COAXIAL** indicators)
- ④ **Remote sensor**
Receives the signal from the remote control unit.
- ⑤ **Disc tray**
- ⑥ **Stop** button (■)
- ⑦ **Track search** buttons (⏮/⏭)
- ⑧ **OPEN/CLOSE** button (⏪)
- ⑨ **Play** button (▶) and indicator
- ⑩ **Pause** button (⏸) and indicator

11. SPECIFICATIONS

1. General

Type	Compact disc digital audio system
Power requirements	
European model	AC 220 - 230 V, 50/60 Hz
U.K. and Australian models	AC 230 - 240 V, 60 Hz
U.S. and Canadian models	AC 120 V, 60Hz
Other models	AC 110/120 - 127/220/240 V (Switchable), 50/60 Hz
Power consumption	
PD-95	30 W
PD-S95	22 W
Operating temperature	+5°C - +35°C +41°F - +95°F
Weight	
PD-95	20.0 kg (44 lb)
PD-S95	17.5 kg (38 lb, 6 oz)
External dimensions	440(W) X 433(D) X 151(H) mm 17-5/16(W) X 17-1/16(D) X 5-15/16(H) in

2. Audio section

PD-95

Frequency response	2 Hz - 20 kHz
S/N ratio	112 dB or more (EIAJ)
Dynamic range	98 dB or more (EIAJ)
Channel separation	108 dB or more (EIAJ)
Harmonic distortion	0.0018% or less (EIAJ)
Output voltage	2.0V
Wow and flutter	Limit of measurement (±0.001% W.PEAK) or less (EIAJ)
Channels	2-channel (stereo)

Balanced type audio line out

(U.S. and Canadian models) 2V (600 Ω)

PD-S95

Wow and flutter	Limit of measurement (±0.001% W.PEAK) or less (EIAJ)
-----------------------	---

3. Output terminal

Unbalanced type audio line output jacks (PD-95 only)

Balanced type audio line output jacks (PD-95 only)

Optical and coaxial digital output jacks (BNC type coaxial digital output jack (PD-S95 only))

Control input/output jacks (U.S. and Canadian models only)

4. Functions

Basic operation buttons

- PLAY, PAUSE, STOP

Search function

- Direct play
- Track search
- Manual search
- Index search
- Time location

Programming

- Maximum 24 steps
- Pause
- Program check/correction
- Program clear (single track or all tracks)

Repeat functions

- 1 track repeat
- All tracks repeat
- Program play repeat
- Random play repeat
- Program random play repeat

Random play (repeat also available)

Switching display

Time consumed, remaining time (track/disc), and total time

Timer start

5. Accessories

● Remote control unit	1
● Size AAA/R03 dry batteries	2
● Turntable sheet	1
● Control cord (U.S. and Canadian models only)	1
● Output cable (PD-95 only)	1
● Operating instructions	1
● Coaxial output cable (PD-S95 only)	1
● Ground lead unit (PD-S95 only)	1

NOTE:

Specifications and design subject to possible modification without notice, due to improvements.

POWER-CORD CAUTION

Handle the power cord by the plug. Do not pull out the plug by tugging the cord and never touch the power cord when your hands are wet as this could cause a short circuit or electric shock. Do not place the unit, a piece of furniture, etc., on the power cord, or pinch the cord. Never make a knot in the cord or tie it with other cords. The power cords should be routed such that they are not likely to be stepped on. A damaged power cord can cause fire or give you an electrical shock. Check the power cord once in a while. When you find it damaged, ask your nearest PIONEER authorized service center or your dealer for a replacement.